

JVC

INSTRUCTIONS

HARD DISK CAMCORDER

GZ-MG77U

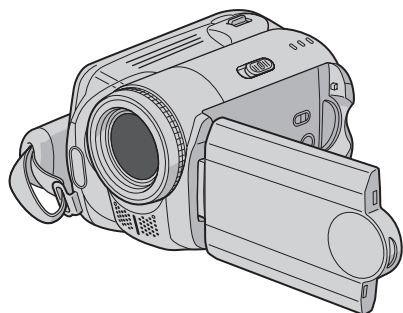

To deactivate the demonstration mode, set "DEMO MODE" to "OFF". (☞ pg. 55)

Dear Customer,

Thank you for purchasing this hard disk camera. Before use, please read the safety information and precautions contained in pages 4 and 5 to ensure safe use of this product.

ENGLISH

GETTING STARTED ... 8

RECORDING  ...18
 ...22

PLAYBACK  ... 28
 ...32

EDITING/PRINTING ...38

DUBBING ...49

MENU SETTINGS ...54

FURTHER INFORMATION ... 60

For Customer Use:

Enter the Model No. (located on the bottom of the camera) and Serial No. (located on the battery pack mount of the camera) below. Retain this information for future reference.

Model No. _____

Serial No. _____

LYT1542-001C

EN

The camera has a built-in high-capacity HDD (hard disk drive) that enables you to record videos and still images in massive quantities.

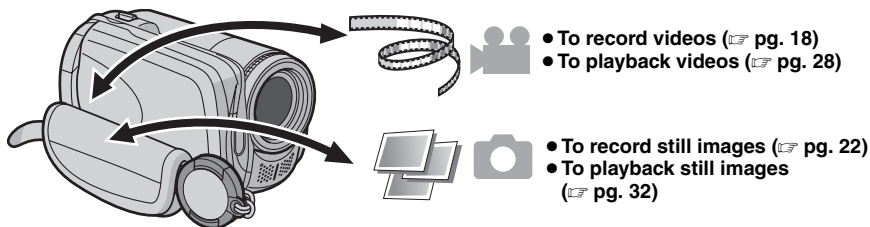

SD Memory Card

You can also record onto SD cards.

“When Using an SD Card” (☞ pg. 17)

Auto/Manual Recording Mode

You can record without using any complicated operations in Auto recording mode.

Manual recording mode, on the other hand, enables you to use special effects and make manual adjustments to record videos that are even more vivid. “To change to manual recording mode” (☞ pg. 24)

DVD Creation Function

(☞ pg. 49)

You can connect the camera to a DVD burner (sold separately) with a USB mini A/B cable to save recorded files easily to a DVD disc.



Video Event Registration

(☞ pg. 19)

You can register recorded videos to events according to their content. This enables you to search and select files by content (event).



Editing Files on Your PC

(☞ SOFTWARE INSTALLATION AND USB CONNECTION GUIDE)

USB 2.0 enables the smooth transfer of video and still images to a computer. With the bundled image editing software, you can easily edit video and create your own DVDs.



Direct Printing

(☞ pg. 48)

If your printer is compatible with PictBridge, still images can be printed easily by connecting the camera directly to the printer with a USB cable.

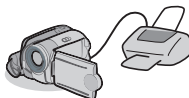

Please read the following instructions before using the camera.

Make a backup of important recorded data

It is recommended to copy your important recorded data to a DVD or other recording media for storage. (☞ pg. 49)

Make a trial recording

Before the actual recording of important data, make a trial recording and play back the recorded data to check that the video and sound have been recorded correctly.

Check the compatibility of recording media

- The SD cards that are guaranteed to work with this camera are those by **Panasonic**, **TOSHIBA**, **pqi** (still image only) and **SanDisk**. If other media are used, they may fail to record data correctly, or they may lose data that had already been recorded.
- For video recording, use a high-speed SD card (at least 10 MB/s).
- MultiMediaCards are not supported.

Format recording medium before use

Before using this camera, format the built-in hard disk or SD cards. This will also ensure stable speeds and operation when accessing the recording medium. (☞ pg. 41)

Make sure you hold the camera correctly during recording

Do not cover the area near the lens, stereo microphone, or camera sensor with your finger or other object while recording. (☞ pg. 10)

When a certain length of time passes without operation

- When using the battery, the power will turn off automatically to conserve power. Use the power switch to turn on the power again.
- When using the AC adapter, the access lamp lights up, and the LCD turns off (the camera enters the sleep mode).

Reset the camera if it does not operate correctly

This camera uses a microcomputer. Factors such as background noise and interference can prevent it from operating correctly. If the camera does not operate correctly, reset the camera. (☞ pg. 60)

If a problem occurs with the SD card, bring the card together with the camera for repairs

When requesting repairs for breakdowns by your dealer or JVC service center, be sure to bring your camera together with the SD card. If one of them is not included, the cause cannot be diagnosed, and the repair cannot be made properly.

Precautions on handling batteries

- When discarding batteries, environmental problems must be considered and the local rules or laws governing the disposal of these batteries must be strictly followed.
- If the camera is subjected to electrostatic discharge, turn the power off before using it again.
- This product includes patented and other proprietary technology and will only operate with a JVC Data Battery. Use the JVC BN-VF707U/VF714U/VF733U battery packs. Using generic non-JVC batteries can cause damage to the internal charging circuitry.
- If the battery operation time remains extremely short even after the battery is fully charged, the battery is worn out and needs to be replaced. Please purchase a new one.
- Since the AC adapter processes electricity internally, it becomes warm during use. Be sure to use it only in well-ventilated areas.
- After 5 minutes has elapsed in record-standby mode, the camera will automatically turn off its power supplied from the AC adapter. In this case, battery charge starts if the battery is attached to the camera.

INFORMATION

Video recording (with sound) that was made especially for demonstration at shops might be remaining on the hard disk of the camera that you have purchased.

To delete this video file, please refer to “Deleting Files” (☞ pg. 38)/“Formatting a Recording Medium” (☞ pg. 41).



CAUTION
RISK OF ELECTRIC SHOCK
DO NOT OPEN



CAUTION: TO REDUCE THE RISK OF ELECTRIC SHOCK,
DO NOT REMOVE COVER (OR BACK).
NO USER-SERVICEABLE PARTS INSIDE.
REFER SERVICING TO QUALIFIED SERVICE PERSONNEL.



The lightning flash with arrowhead symbol, within an equilateral triangle, is intended to alert the user to the presence of uninsulated "dangerous voltage" within the product's enclosure that may be of sufficient magnitude to constitute a risk of electric shock to persons.



The exclamation point within an equilateral triangle is intended to alert the user to the presence of important operating and maintenance (servicing) instructions in the literature accompanying the appliance.

WARNING: TO PREVENT FIRE OR SHOCK HAZARD, DO NOT EXPOSE THIS UNIT TO RAIN OR MOISTURE.

NOTES:

- The rating plate and safety caution are on the bottom and/or the back of the main unit.
- The serial number plate is on the battery pack mount.
- The rating information and safety caution of the AC adapter are on its upper and lower sides.

Caution on Replaceable lithium battery

The battery used in this device may present a fire or chemical burn hazard if mistreated. Do not recharge, disassemble, heat above 100°C or incinerate.

Replace battery with Panasonic (Matsushita Electric), Sanyo, Sony or Maxell CR2025.

Danger of explosion or Risk of fire if the battery is incorrectly replaced.

- Dispose of used battery promptly.
- Keep away from children.
- Do not disassemble and do not dispose of in fire.

When the equipment is installed in a cabinet or on a shelf, make sure that it has sufficient space on all sides to allow for ventilation (10 cm (3-15/16") or more on both sides, on top and at the rear).

Do not block the ventilation holes. (If the ventilation holes are blocked by a newspaper, or cloth etc. the heat may not be able to get out.)

No naked flame sources, such as lighted candles, should be placed on the apparatus.

When discarding batteries, environmental problems must be considered and the local rules or laws governing the disposal of these batteries must be followed strictly.

The apparatus shall not be exposed to dripping or splashing.

Do not use this equipment in a bathroom or places with water.

Also do not place any containers filled with water or liquids (such as cosmetics or medicines, flower vases, potted plants, cups etc.) on top of this unit.

(If water or liquid is allowed to enter this equipment, fire or electric shock may be caused.)

Do not point the lens directly into the sun. This can cause eye injuries, as well as lead to the malfunctioning of internal circuitry. There is also a risk of fire or electric shock.

CAUTION!

The following notes concern possible physical damage to the camera and to the user.

Carrying or holding the camera by the LCD monitor can result in dropping the unit, or in a malfunction.

Do not use a tripod on unsteady or uneven surfaces. It could tip over, causing serious damage to the camera.

CAUTION!

Connecting cables (Audio/Video, S-Video, etc.) to the camera and leaving it on top of the TV is not recommended, as tripping on the cables will cause the camera to fall, resulting in damage.

IMPORTANT SAFETY INSTRUCTIONS

1. Read these instructions.
2. Keep these instructions.
3. Heed all warnings.
4. Follow all instructions.
5. Do not use this apparatus near water.
6. Clean only with dry cloth.
7. Do not block any ventilation openings. Install in accordance with the manufacturer's instructions.
8. Do not install near any heat sources such as radiators, heat registers, stoves, or other apparatus (including amplifiers) that produce heat.
9. Only use attachments/accessories specified by the manufacturer.
10. Use only with the cart, stand, tripod, bracket, or table specified by the manufacturer, or sold with the apparatus. When a cart is used, use caution when moving the cart/apparatus combination to avoid injury from tip-over.
11. Unplug this apparatus during lightning storms or when unused for long periods of time.
12. Refer all servicing to qualified service personnel. Servicing is required when the apparatus has been damaged in any way, such as power-supply cord or plug is damaged, liquid has been spilled or objects have fallen into the apparatus, the apparatus has been exposed to rain or moisture, does not operate normally, or has been dropped.



Remember that this camera is intended for private consumer use only.

Any commercial use without proper permission is prohibited. (Even if you record an event such as a show, performance or exhibition for personal enjoyment, it is strongly recommended that you obtain permission beforehand.)

Trademarks

- Manufactured under license from Dolby Laboratories. "Dolby" and double-D symbol are trademarks of Dolby Laboratories.



MascotCapsule is a registered trademark of HI CORPORATION in Japan.

Copyright © 2001 HI CORPORATION. All rights reserved.

- Other product and company names included in this instruction manual are trademarks and/or registered trademarks of their respective holders.

GETTING STARTED

Accessories	8
Attaching the Shoulder Strap	9
Attaching the Lens Cap	9
Attaching the Core Filter	9
Index	10
Indications on LCD Monitor	12
Necessary Settings before Use	14
Power Related Preparations (Using the Battery Pack)	14
Language Setting	15
Date/Time Setting	15
Other Settings	16
Grip Adjustment	16
Tripod Mounting	16
Data Battery System	16
When Using an SD Card	17

RECORDING *Video*

Video Recording	18
Registering Files to Events	19
Zooming	20
Changing the Screen Size	20
Deleting a File	21
Checking the Remaining Space on the Recording Media	21

 *Still image*

Still Image Recording	22
Zooming	23
Continuous Shooting	23
Flash	23
Deleting a File	23

  *Video / Still image*

Manual Recording	24
Manual Setting in MSET Menu	24
Nightalive	27
Backlight Compensation	27
Spot Exposure Control	27

PLAYBACK *Video*

Video Playback	28
Various Operations during Playback	29
File Search Function	30
Date Index Screen	30
Event Screen	31
To Play Back Files in the [EXTMOV] Folder	31
Deleting a Video File	31

 *Still image*

Still Image Playback	32
File Search Function	32
Slide Show	33
Image Rotation	33
Playback Zoom	33
Deleting a Still Image File	33

  *Video / Still image*

Watching Images on TV/Remote Control	34
Connecting to a TV, VCR or DVD Recorder	34
Playback on TV	34
Playback Using the Remote Control	35
Playback with Special Effects	36

EDITING/PRINTING  *Video / Still image*

Managing Files	38
Deleting Files	38
Viewing File Information	39
Protecting Files from Accidental Erasure	40
Formatting a Recording Medium	41
Cleaning Up a Recording Medium	42
Resetting the File Number	42
Changing the Event Registration of Video Files after Recording	43

Video

Playlists	44
Creating Playlists	44
Playing Back Playlists	46
Other Operations of Playlists	46

Still image

Print Setting	47
DPOF Print Setting	47
Direct Printing with PictBridge Printer	48

DUBBING

Video

Dubbing Video Files to DVD Discs	49
Using a DVD Burner for Dubbing (DVD Creation Function)	49
Using a VCR/DVD Recorder for Dubbing	52

Still image

Copying/Moving Still Image Files	53
---	-----------

MENU SETTINGS

Changing the Menu Settings	54
Common Menus for All Modes	55
Video Recording Menus	57
Video Playback Menus	58
Still Image Recording Menus	59
Still Image Playback Menus	59

FURTHER INFORMATION

Troubleshooting	60
Warning Indications	64
Cleaning the Camera	66
Cautions	67
Specifications	70
TERMS	Back cover

Regarding This Manual

Button operations

- Button operations are illustrated as shown below.



• Regarding the control lever (pg. 11)

There are two kinds of operation using the control lever: moving the lever towards up/down/left/right, or pressing down the lever. They are described and illustrated as shown below.

ex.)

- 1) Move the control lever downward:



Press ∇ .

- 2) Press down the control lever:



Press \blacktriangleright II.

- 3) Operate 1) and 2) continuously:



Press $\wedge/\vee/\langle/\rangle$ to select, then press \blacktriangleright II.

Icons at the top of pages

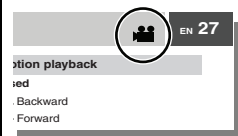

When there are icons at the top of pages, they show whether the page is related to videos and/or still images.



Page related to videos



Page related to still images



Page common to videos and still images

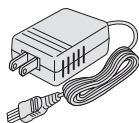

or

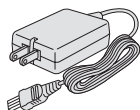

AC Adapter
AP-V18U / AP-V14U



Battery Pack
BN-VF707U



Audio/Video Cable

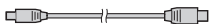

USB Cable
(☞ SOFTWARE
INSTALLATION AND
USB CONNECTION
GUIDE)



Shoulder Strap
(☞ pg. 9)



Lens Cap (☞ pg. 9)

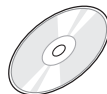

CD-ROM



Remote Control Unit
RM-V730U (☞ pg. 35)



Lithium Battery
CR2025 (for remote
control unit)
Pre-installed in the
remote control unit at
time of shipment.

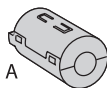

A



B



Core Filter for Cables (☞ pg. 9)
Large-A (x 1): Audio/Video Cable
Large-B (x 2): USB/S-Video Cable
Small (x 1): DC Cord

Attaching the Shoulder Strap

Peel off the pad and thread the end of the strap through the eyelet.

Thread the strap through the buckle, adjust its length, and use the strap guide to fix it in place.

Position the buckle near the eyelet and reattach the pad.

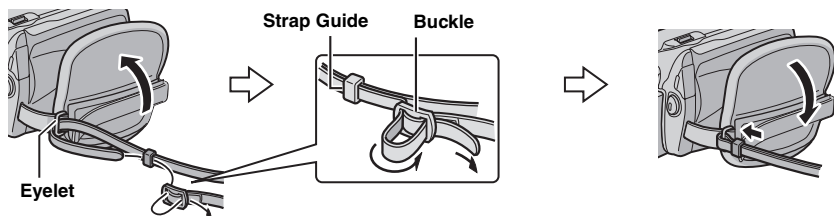

Attaching the Lens Cap

To protect the lens, attach the provided lens cap to the camera as shown in the illustration.

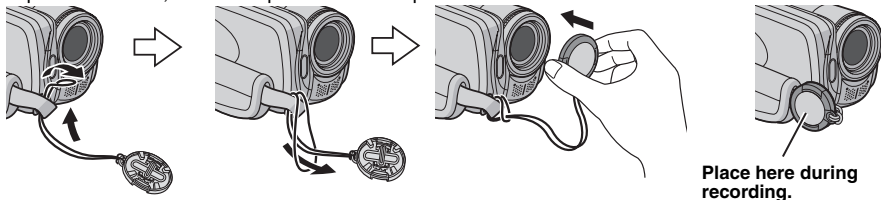

Attaching the Core Filter

Attach the core filters to the cables. The core filter reduces interference. When connecting a cable, attach the end with the core filter to the camera.

Attachment positions
(right)

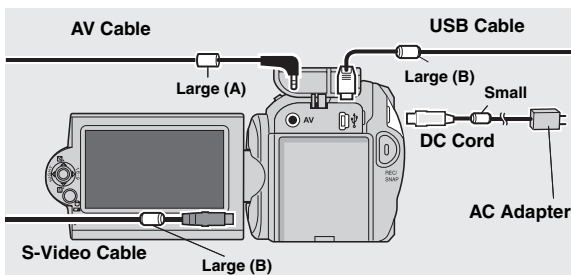



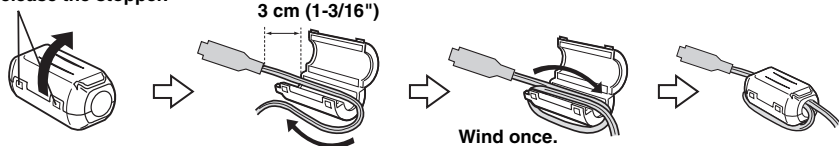

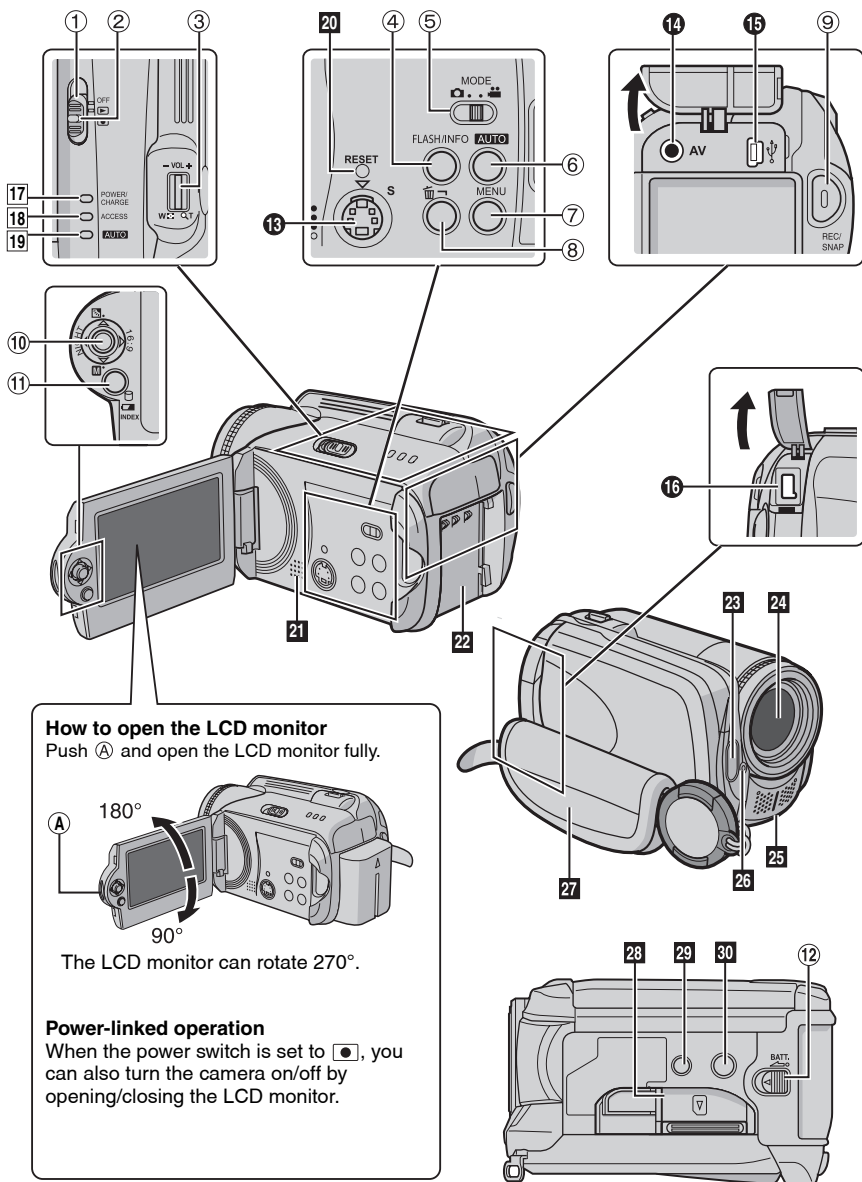







Release the stopper.





Controls

- ① Power Switch [OFF, , - ② Lock Button (↗ pg. 14)
- ③ Zoom Lever [W /T ] (↗ pg. 20)
Speaker Volume Control [-VOL+] (↗ pg. 28)
- ④ Flash Button [FLASH] (↗ pg. 23)/
Information Button [INFO] (↗ pg. 39)
- ⑤ Mode Switch [MODE] (↗ pg. 18, 22, 28, 32)
- ⑥ Auto/Manual Mode Button [AUTO]
(↗ pg. 24)
- ⑦ Menu Button [MENU] (↗ pg. 54)
- ⑧ Delete Button [] (↗ pg. 21)
- ⑨ Recording Start/Stop Button [REC/SNAP]
(↗ pg. 18, 22)
- ⑩ Control Lever
 - ∧ : Reverse Skip (↗ pg. 29)/Up/Backlight
Compensation [] (↗ pg. 27)/Spot
Exposure Control [] (↗ pg. 27)
 - ∨ : Forward Skip (↗ pg. 29)/Down/Manual
Set [] (↗ pg. 24)
 - < : Reverse Search [] (↗ pg. 29)/Left/
Nightlive [NIGHT] (↗ pg. 27)
 - > : Forward Search [] (↗ pg. 29)/Right/
Switch Screen Size (16:9/4:3) [16:9]
(↗ pg. 20)

Press down: Play/Pause [] (↗ pg. 28, 32)
- ⑪ Index Button [INDEX] (↗ pg. 30)/Remaining
Space Button [] (↗ pg. 21)/Data Battery
Button [] (↗ pg. 16)
- ⑫ Battery Release Button [BATT.] (↗ pg. 14)

Connectors

The connectors are located beneath the covers.

- ⑬ S-Video Output Connector [S] (↗ pg. 34)
- ⑭ Audio/Video Output Connector [AV]
- ⑮ USB (Universal Serial Bus) Connector
(↗ SOFTWARE INSTALLATION AND USB
CONNECTION GUIDE)
- ⑯ DC Input Connector [DC] (↗ pg. 14)

Indicators

- ⑰ Power/Charge Lamp [POWER/CHARGE]
(↗ pg. 14)
- ⑱ Access Lamp [ACCESS] (Lights up or blinks
when you access files. Do not turn off the
power or remove the battery pack/AC
adapter while accessing files.)
- ⑲ Auto Lamp [AUTO] (Lights up in Auto
recording mode. Also lights up when
connecting to a DVD burner [sold
separately].) (↗ pg. 49)

Other Parts

- ⑳ Reset Button [RESET] (↗ pg. 60)
- ㉑ Speaker (↗ pg. 28)
- ㉒ Battery Pack Mount (↗ pg. 14)
- ㉓ Flash (↗ pg. 23)
- ㉔ Lens
- ㉕ Stereo Microphone
- ㉖ Camera Sensor
Remote Sensor (↗ pg. 35)
Flash Sensor
- ㉗ Grip Strap (↗ pg. 16)
- ㉘ SD Card Cover [OPEN] (↗ pg. 17)
- ㉙ Stud Hole (↗ pg. 16)
- ㉚ Tripod Mounting Socket (↗ pg. 16)

ATTENTION:

- Be careful not to cover ㉓, ㉔, ㉕ and ㉖ during shooting.
- Carrying or holding the camera by the LCD monitor can result in dropping the unit, or in a malfunction.

During both Video and Still Image Recording

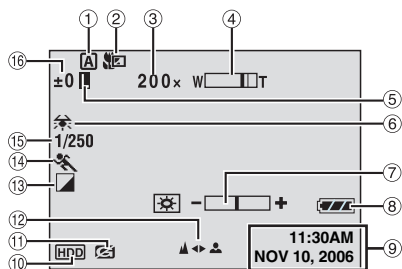

- ① Selected Operation Mode Indicator (☞ pg. 24)
A: Auto Mode
M: Manual Mode
- ② Tele Macro Mode Indicator (☞ pg. 57, 59)
- ③ Approximate Zoom Ratio (☞ pg. 20, 23)
- ④ Zoom Indicator (☞ pg. 20, 23)
- ⑤ Iris Lock Indicator (☞ pg. 25)
- ⑥ White Balance Indicator (☞ pg. 25)
- ⑦ Brightness Control Indicator (☞ pg. 56)
- ⑧ Battery Indicator (☞ pg. 64)
- ⑨ Date/Time (☞ pg. 56)
- ⑩ Selected Medium Indicator (☞ pg. 17, 56)
- ⑪ Drop Detection Indicator (☞ pg. 55)
- ⑫ Manual Focus Adjustment Indicator (☞ pg. 25)
- ⑬ Effect Mode Indicator (☞ pg. 26)
- ⑭ Program AE Mode Indicator (☞ pg. 26)
- ⑮ Shutter Speed (☞ pg. 26)
1/250 A: Nightlive Indicator (☞ pg. 27)
- ⑯ **±**: Exposure Adjustment Indicator (☞ pg. 25)
- ⑰ **☀**: Backlight Compensation Indicator (☞ pg. 27)
- ⑱ **☑**: Spot Exposure Control Indicator (☞ pg. 27)

During Video Recording Only

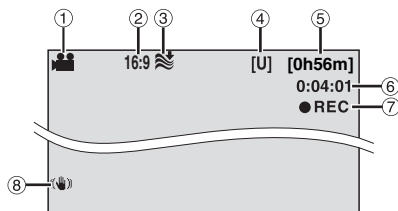

- ① Mode Indicator (☞ pg. 18)
- ② Screen Size Indicator (☞ pg. 20)
- ③ Wind Cut Indicator (☞ pg. 57)
- ④ Picture Quality: [U] (ultra fine), [F] (fine), [N] (normal), [E] (economy) (☞ pg. 57)
- ⑤ Remaining Time (☞ pg. 18, 71)
- ⑥ Counter (☞ pg. 56)
- ⑦ ●REC: (Appears during recording.) (☞ pg. 18)
 ●■■: (Appears during record-standby mode.)
- ⑧ Digital Image Stabilizer (DIS) Indicator (☞ pg. 57)

During Still Image Recording Only

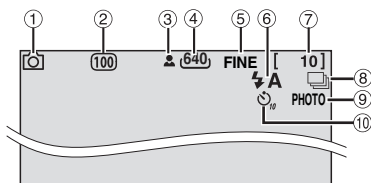

- ① Mode Indicator (☞ pg. 22)
- ② ISO sensitivity (GAIN) (☞ pg. 59)
 (When set to [AUTO], there is no indication.)
- ③ Focus Indicator (☞ pg. 22)
- ④ Image Size: 1632 (1632 x 1224), 1280 (1280 x 960), 1024 (1024 x 768), 640 (640 x 480) (☞ pg. 59)
- ⑤ Picture Quality: FINE (fine) or STD (standard) (☞ pg. 59)
- ⑥ Flash Mode Indicator (☞ pg. 23)
- ⑦ Remaining Number of Shots (☞ pg. 71)
- ⑧ **☑**: Continuous Shooting Mode Indicator (☞ pg. 23)
- ⑨ Shooting Indicator (☞ pg. 22)
- ⑩ Self-Timer Recording Indicator (☞ pg. 59)

During Video Playback

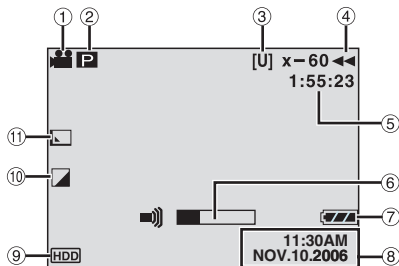

- ① Mode Indicator (☞ pg. 28)
- ② **P**: Playlist Playback Indicator (Appears when playing back a playlist. ☞ pg. 46)
 ☺E: Event Search Playback Indicator (Appears when playing back a video file from the event search. ☞ pg. 31)
 ☺D: Date Search Playback Indicator (Appears when playing back a video file from the date search. ☞ pg. 30)
- ③ Picture Quality: [U] (ultra fine), [F] (fine), [N] (normal), [E] (economy) (☞ pg. 57)
- ④ Playback Mode (☞ pg. 29)
 ▶ : Playback
 || : Pause
 ▶▶ : Forward High-Speed Search
 ◀◀ : Reverse High-Speed Search
 ||▶ : Forward Slow-Motion
 ◀|| : Reverse Slow-Motion
 (The number on the left shows speed.)
- ⑤ Counter (☞ pg. 56)
- ⑥ Volume Level Indicator
- ⑦ Battery Indicator (☞ pg. 64)
- ⑧ Date/Time (☞ pg. 56)
- ⑨ Selected Medium Indicator (☞ pg. 17, 56)
- ⑩ Effect Mode Indicator (☞ pg. 36)
- ⑪ Wipe/Fader Effect Indicator (☞ pg. 36)

During Still Image Playback

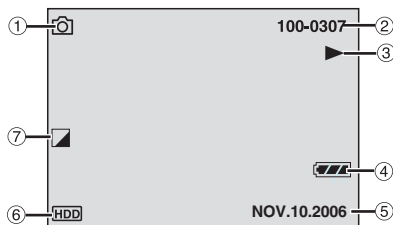

- ① Mode Indicator (☞ pg. 32)
- ② Folder/File Number
- ③ Slide Show Playback Indicator (☞ pg. 33)
- ④ Battery Indicator (☞ pg. 64)
- ⑤ Date (☞ pg. 56)
- ⑥ Selected Medium Indicator (☞ pg. 17, 56)
- ⑦ Effect Mode Indicator (☞ pg. 36)

Be sure to configure the following three settings before use.

Power Related Preparations (Using the Battery Pack)

1 Set the power switch to OFF.

Slide while pressing down the lock button.

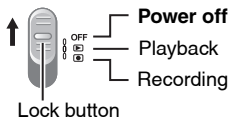

2 Attach the battery pack.

Slide the battery pack down until it locks in place.

Bottom of the Camera

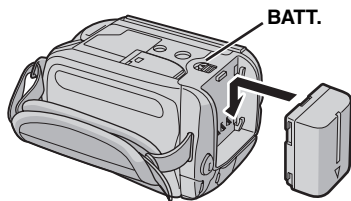

3 Charge the battery pack by connecting to the AC adapter.

Open the cover.

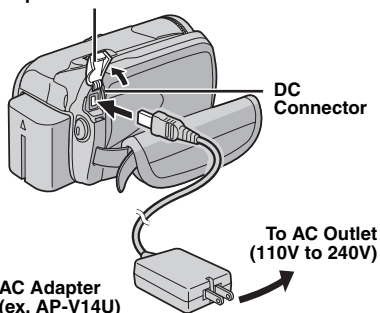

- The power/charge lamp blinks to indicate charging has started.
- When the lamp goes out, charging is finished. Unplug the AC adapter from the AC outlet and disconnect the AC adapter from the camera.

To detach the battery pack

Slide and hold **BATT.** (☞ step 2), then remove the battery pack.

To check the remaining battery power (☞ pg. 16)

Required charging / recording time

Battery pack	Charging time	Recording time
BN-VF707U (Provided)	1 hr. 30 min.	1 hr.
BN-VF714U	2 hr. 40 min.	2 hr. 5 min.
BN-VF733U	5 hr. 40 min.	4 hr. 55 min.

The times shown above are approximate times.

NOTE:

You can also use the camera with just the AC adapter.

Controls in this section

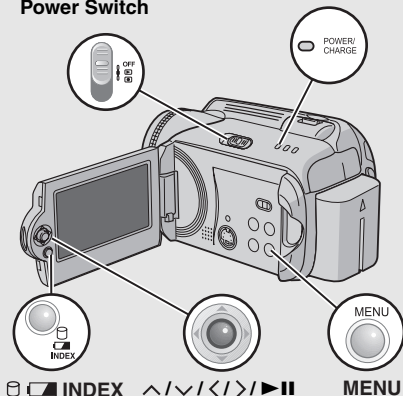

Power/Charge Lamp

Power Switch



Language Setting

The language on the display can be changed. (☞ pg. 56)

- 1 Open the LCD monitor. (☞ pg. 10)
- 2 Set the power switch to  or . Slide while pressing down the lock button.

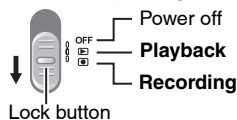

- 3  MENU
- 

- 4 Select [DATE/DISPLAY].

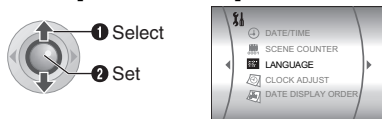

- 5 Select [LANGUAGE].



- 6 Select the desired language.



- 7  MENU

Date/Time Setting

The recording start date/time is recorded on the video/still image file and it can be checked by pressing **INFO**. (☞ pg. 28, 32)
In addition, you can find the desired file from the date index screen. (☞ pg. 30)

After performing step 1-4 in “Language Setting” (☞ pg. 15)

- 5 Select [CLOCK ADJUST].

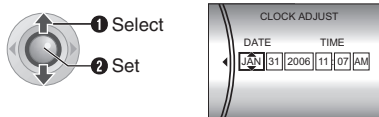

- 6 Set the date and time.



Repeat this step to input the month, day, year, hour and minute.

- 7  MENU

You have now finished configuring the necessary settings.

To use the camera right away

To record videos (☞ pg. 18)

To record still images (☞ pg. 22)

To configure other settings (☞ pg. 16)

Check which buttons to use in the illustration of "Controls in this section" on page 14.

Grip Adjustment

Open the pad and make grip adjustments.

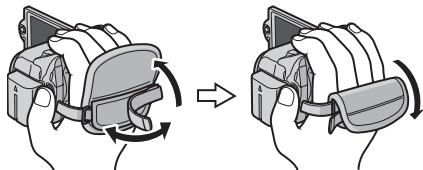

Tripod Mounting

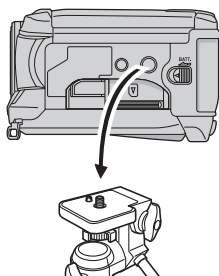

Bottom of the Camera

Align the camera stud hole with the tripod stud, and the mounting socket with the screw, and then rotate the camera clockwise to mount it to the tripod.

NOTE:

Do not use a tripod on unsteady or unlevel surfaces. It could tip over, causing serious damage to the camera.

Data Battery System

You can check the remaining battery power and the recordable time.

When the battery is attached

1 Set the power switch to OFF.

Slide while pressing down the lock button.

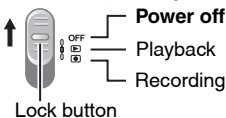

2

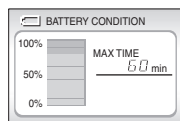

NOTES:

- Battery information is displayed for approx. 5 seconds if the button is pressed and released quickly, and for approx. 15 seconds if the button is pressed and held for several seconds.
- If "COMMUNICATING ERROR" appears instead of the battery status even though you tried to press several times, there may be a problem with your battery. In such a case, consult your nearest JVC dealer.
- The recordable time display should only be used as a guide. It is displayed in 10 minute units.

When Using an SD Card

By default, the HDD is set as the recording medium. If you want to record to an SD card, the following three operations need to be performed.

NOTE:

For details on compatible SD cards, see "Check the compatibility of recording media" (pg. 3).

Insert an SD card

Insert and remove the SD card only while the power is turned off. Otherwise, data on the card may be corrupted.

1 Open the SD card cover.

Bottom of the Camera

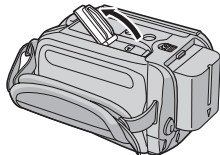

2 Firmly insert the card with its clipped edge first.

Clipped Edge

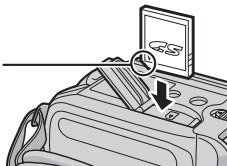

Do not touch the terminal on the reverse side of the label.

3 Close the SD card cover.

To remove an SD card

Push the SD card once.

After the card comes out a little, pull it out.

Change the recording medium

Preparation:

- Set the power switch to or .

1

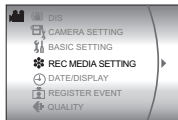

2 Select [REC MEDIA SETTING].



3 Select [VIDEO MODE] or [IMAGE MODE].

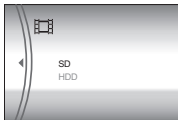

4 Select [SD].



5



To change the recording medium back to the HDD

Select [HDD] in step 4.

Format an SD card when using it for the first time

This will also ensure stable speeds and operation when accessing the SD card. For details on how to format an SD card, see "Formatting a Recording Medium" (pg. 41).

Preparation: Open the LCD monitor. (▶ pg. 10)

1 Set the power switch to .

Slide while pressing down the lock button.

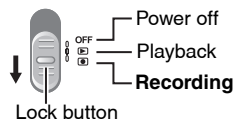

2 Set the MODE switch to .

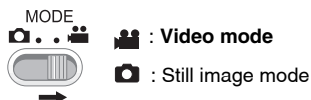

- The camera is programmed to record videos on the built-in hard disk when it is shipped from the factory. To change the recording medium, see page 17.

3 Press the REC/SNAP button to start recording.

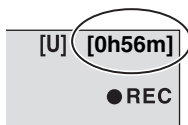

- Approximate remaining time for recording appears.

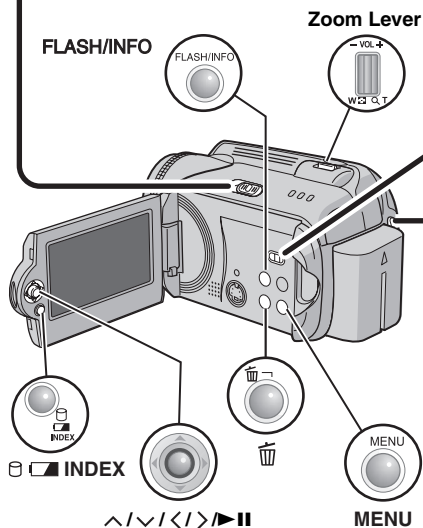

To stop recording

Press the **REC/SNAP** button again.

To change the picture quality (▶ pg. 57)

To register a file to an event (▶ pg. 19)



NOTES:

- By default, the camera is set to record videos in 4:3 size. To record videos in 16:9 size, see "Changing the Screen Size" (☞ pg. 20).
- If the camera is not operated during recording or playback for 5 minutes when using the battery pack, it turns itself off automatically to conserve power. To turn the camera on again, set the power switch to **OFF**, then to or . When using the AC adapter, the camera enters the sleep mode (the access lamp lights and the LCD monitor turns off). To cancel the sleep mode, perform any operation such as zooming.
- When the camera heats up, the **●REC** indicator flashes. If the camera continues to heat up, shooting may be stopped to protect the recording medium. In this case, turn off the power, and then wait until the camera cools down.
- If data cannot be recorded or saved properly, the video files are not saved to the [SD_VIDEO] folder, which is for regular videos. Instead, the files are saved to the [EXTMOV] folder. To play back these files, see "To Play Back Files in the [EXTMOV] Folder" (☞ pg. 31).
- Video files are given the names MOV_001.MOD to MOV_009.MOD, MOV_00A.MOD to MOV_00F.MOD, and MOV_010.MOD in order of recording.
- After recording video for 12 consecutive hours, recording stops automatically.
- A new file will be created for every 4 GB of continuous shooting.
- This camera records video in MPEG2 format compliant with SD-VIDEO format. Remember that this camera is not compatible with other digital video formats.
- Before recording important video, be sure to make a trial recording.
- Do not move or shake the camera suddenly during recording. If you do, the sound of the hard disk drive may be recorded.

Preparation:

- Set the power switch to .
- Set the **MODE** switch to .

1



2 Select [REGISTER EVENT].



3 Select [ON/SELECT].

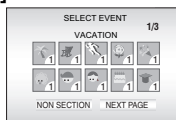

4 Select the event that you want to register the file to.



- To select a different destination, select [NEXT PAGE].
- To cancel the event registration, select [NON SECTION].

The selected event is displayed on the screen. Press the **REC/SNAP** button to start recording.

To search by event for a file to play back
(☞ pg. 31)

NOTE:

Once you select to register a file to a certain event, the setting will remain even if you turn the power off. Unless you change the setting, you will register a file to the same event that you had previously selected.

Registering Files to Events

If you select an event to register the file to before starting recording, the file will be registered to the selected event, thus making the file easy to find at playback. There are up to 3 different destinations within each event (for example: BABY1, BABY2, BABY3).

Zooming

While recording

Zoom out



Zoom in



W: Wide angle

T: Telephoto

- You can zoom in up to 10x by using the optical zoom.
- Zoom magnification over 10x is done through digital image processing, and is therefore called digital zoom. Digital zooming is possible up to 300x. Set [ZOOM] to [40X] or [300X]. (pg. 57)

Optical zoom (up to 10x)



Digital zoom (up to 300x)

NOTES:

- Macro shooting is possible as close as approx. 5 cm (2") to the subject when the zoom lever is set all the way to **W**.
- When you zoom into a subject close to the lens, the camera may automatically zoom out depending on the distance to the subject. In this case, set [TELE MACRO] to [ON]. (pg. 57)

Changing the Screen Size

You can record videos at 4:3 size and 16:9 size. By default, the camera is set to record videos at the 4:3 size.

Preparation:

- Set the power switch to
- Set the **MODE** switch to



Each press switches the screen size.

ATTENTION:

Videos which have been recorded in 16:9 mode may appear to be slightly vertically stretched on a 4:3 screen TV. Record videos in 4:3 size if playing back on a 4:3 screen TV.

NOTES:

- If the recording mode is set to **ECONOMY**, you cannot change the screen size.
- If you want to burn the recorded videos onto DVD discs, it is recommended not to mix 16:9 size videos and 4:3 size videos.
- If you record videos in 16:9 size, the image may appear to be slightly vertically stretched when playing back on TV with the 4:3 screen.

Deleting a File

The file most recently recorded will be deleted.

After the recording is finished

1

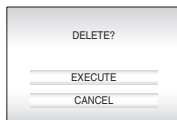

2 Select [EXECUTE].





NOTE:

If the recording mode (video or still image) is switched, or the power is turned off and on again after recording, you cannot delete the file.

Checking the Remaining Space on the Recording Media

Preparation:

- Set the power switch to .
- Set the **MODE** switch to .

Example: When checking the HDD space



The maximum recording time is displayed for each picture quality mode, and the remaining space is indicated by a pie chart.

Displayed picture quality mode

U: ULTRA FINE

F: FINE

N: NORMAL

E: ECONOMY

For details on the picture quality, see page 71.

To return to the normal screen



Press the  button again.

Preparation: Open the LCD monitor. (▶ pg. 10)

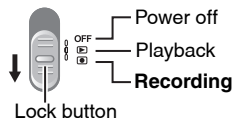
1 Set the power switch to .
Slide while pressing down the lock button.



2 Set the MODE switch to .

MODE
 : Video mode
 : Still image mode

• The camera is programmed to record still images on the built-in hard disk when it is shipped from the factory. To change the recording medium, see page 17.

3 Press the REC/SNAP button to start recording.

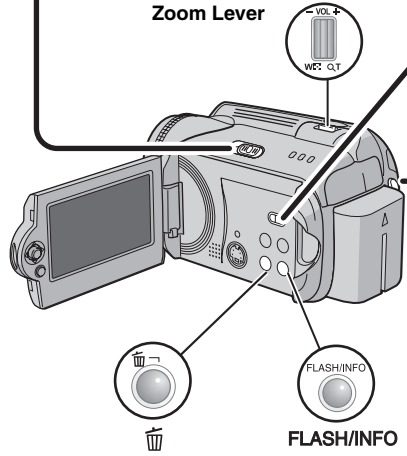
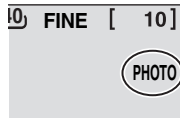



The **PHOTO** indicator appears during recording.

• To check how the image looks before recording, press the **REC/SNAP** button halfway and hold. The  indicator appears and becomes green when the captured image is focused. To cancel the recording, release the **REC/SNAP** button. To record it on the recording medium, press the **REC/SNAP** button fully.

To change the picture quality (▶ pg. 59)

NOTES:

- Still images are recorded at 4:3 size. They cannot be recorded at 16:9 size.
- If the camera is not operated during recording or playback for 5 minutes when using the battery pack, it turns itself off automatically to conserve power. To turn the camera on again, set the power switch to **OFF**, then to  or . When using the AC adapter, the camera enters the sleep mode (the access lamp lights and the LCD monitor turns off). To cancel the sleep mode, perform any operation such as zooming.



Zooming

While recording

Zoom out

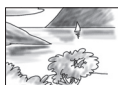

W: Wide angle



Zoom in

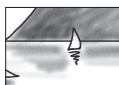

T: Telephoto

- You can zoom up to 10x by using the optical zoom.
- Digital zoom (pg. 20) is not available.

Continuous Shooting

If the continuous shooting mode is set to on, keeping the **REC/SNAP** button pressed in step 3 (pg. 22) provides an effect similar to serial photography. (Interval between still images: approx. 0.3 seconds)

Preparation:

- Set the power switch to
- Set the **MODE** switch to

Set the **[CONTINUOUS SHOOTING]** to **[ON]**. (pg. 59)

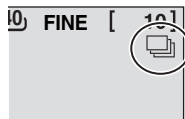

The indicator appears.

- Continuous shooting may not work well depending on the recording medium.
- The continuous shooting speed will drop if this function is used repeatedly.

Flash

You can use the flash for still image recording. The flash setting can be changed as required.

Preparation:

- Set the power switch to .
- Set the **MODE** switch to .

FLASH/INFO

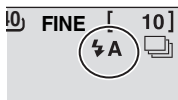

To change the flash setting

Each time you press the button, setting changes. ([] = Factory-preset)

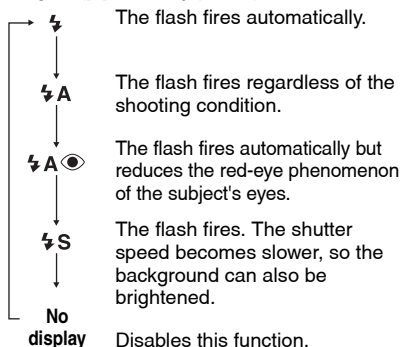

Deleting a File

The file most recently recorded will be deleted.

After the recording is finished

1

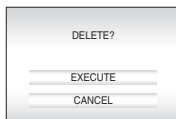

2 Select [EXECUTE].



1 Select

2 Set

NOTE:

If the recording mode (video or still image) is switched, or the power is turned off and on again after recording, you cannot delete the file.

About manual recording mode

This mode enables you to set the focus and screen brightness manually. You need to switch to this mode because auto recording mode, which adjusts these settings automatically, is selected by default.

To change to manual recording mode**Preparation:**

- Set the power switch to .
- Select the file type (video or still image) using the **MODE** switch.

AUTO



Press twice.



The **M** indicator appears.

To return to the auto recording mode

Press the **AUTO** button so that the **A** indicator appears.

Controls in this section

Power Switch

MODE Switch

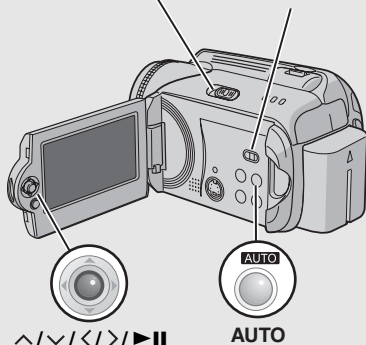
**Manual Setting in MSET Menu**

You can use manual recording functions easily by selecting items in the MSET menus.

After performing “To change to manual recording mode” (pg. 24)

1

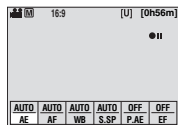

2

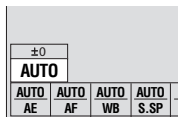
Select the desired menu.

For details on each menu, see pages 25 and 26.

3

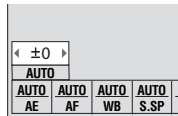
Select the desired setting.

Depending on the kind of settings you select, you can set the value with **</>** after selecting.

4











5



The menu disappears and the indicator for the set function appears.

MSET Menu

Menus	Settings ([] = Factory-preset)
AE (Manual Exposure) Adjusts the brightness.	For video recording [AUTO]: The brightness is adjusted automatically. -6 to +6: Corrects the brightness within this range in increments of 1. Use </> to set the value. For still image recording [±0]: The brightness is not adjusted. -2.0 to +2.0 (EV): Corrects the brightness within this range in increments of 1/3EV. Use </> to set the value. To lock the exposure When the menu disappears after you finish configuring the setting, press and hold ► for more than 2 seconds. The  indicator appears.
AF (Manual Focus) Adjusts the focus.	[AUTO]: The focus is adjusted automatically. ▲ ◀ ▶ 👤 : Adjusts the focus manually. Use </> to set the focus. (When zooming, the subject will not go out of focus if you adjust the focus at the telephoto (T) side before zooming to the wide-angle (W) side.)
WB (White Balance) Adjusts the white balance to achieve the optimum colors for the amount of light in your surroundings during recording.	[AUTO]: White balance is adjusted automatically.  MWB: Adjusts the white balance manually depending on the light source. 1) Hold a sheet of plain white paper in front of the subject. Adjust the zoom, or position yourself so that the white paper fills the screen. 2) Press and hold ► until the  indicator starts blinking then stops blinking.  — White paper   FINE : When shooting outdoors on a sunny day.  CLOUD : When shooting outdoors on a cloudy day.  HALOGEN : When a video light or similar type of lighting is used.

MSET Menu (Continued)

Menus

Settings ([] = Factory-preset)

S.SP**(Shutter Speed)**

A fast shutter speed can freeze the motion of a fast-moving subject, and a slow shutter speed can blur the subject to give the impression of motion.

[AUTO]: The shutter speed is adjusted automatically.

1/2 to 1/4000 (For video recording) /

1/2 to 1/500 (For still image recording):

The smaller the value, the faster the shutter speed. Use </> to set the value.

NOTE:

It is recommended to use the tripod (pg. 16) when recording with a slow shutter speed.

P.AE**(Program AE)**

You can use the program AE settings for specific shooting situations.

[OFF]: The brightness is adjusted automatically.



SPORTS: Records fast moving subjects clearly.



SNOW: Compensates for subjects that may appear too dark when shooting in extremely bright surroundings, such as in snow.



SPOTLIGHT: Select this when a spotlight makes a subject appear too bright.



TWILIGHT: Makes evening scenes look more natural.

EF**(Effect)**

You can record videos or still images with special effects.

[OFF]: No effect is used.



SEPIA: The image has a brownish tint like old photos.



MONOTONE: The image becomes black and white like old movies.



CLASSIC FILM*: This effect skips frames to give images of an old movie atmosphere.



STROBE*: The image looks like a series of consecutive snapshots.

* Not available for still image recording.

Nightlive

The shutter speed is automatically adjusted from 1/2 to 1/15 seconds. It enables recording with little light in dim locations.

After performing “To change to manual recording mode” (➔ pg. 24)



The  indicator appears.

To cancel nightlive

Press < (NIGHT) so that the  indicator disappears.

NOTE:

It is recommended to use the tripod (➔ pg. 16) when recording with a slow shutter speed.

Backlight Compensation



Backlight compensation brightens the subject quickly. With a simple operation, dark portions of the subject are brightened by increasing the exposure.

After performing “To change to manual recording mode” (➔ pg. 24)



The  indicator appears.

To cancel backlight compensation

Press ^ () twice so that the  indicator disappears.

Spot Exposure Control

Selection of a spot metering area enables more precise exposure compensation. You can select one of the three metering areas.

After performing “To change to manual recording mode” (➔ pg. 24)

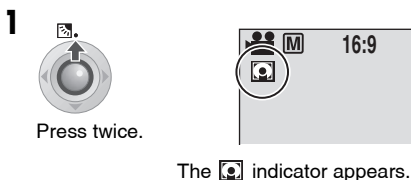



The  indicator appears.



2 Select the desired spot metering area frame.



To lock the exposure

After you finish configuring the setting, press and hold  for more than 2 seconds. The  indicator appears.

To cancel spot exposure control

Press ^ () once so that the  indicator disappears.

1 Set the power switch to .

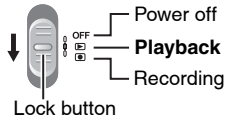

Slide while pressing down the lock button.







Power off
Playback
Recording

Lock button

2 Set the MODE switch to .

MODE
 : Video mode
 : Still image mode

3 Press /// to select the desired file, then press .

Zoom Lever/Speaker Volume Control

FLASH/INFO

FLASH/INFO

WZT OUT

INDEX

INDEX screen for videos

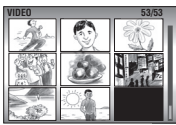

- To change the medium to be played back, see page 17.
- To pause playback, press  again.

INDEX

To return to the index screen

Press **INDEX** when playback is paused.

To adjust the speaker volume

During playback, slide the speaker volume control towards + to turn the volume up, or towards – to turn the volume down.

To turn the date display on/off

Set [DATE/TIME] to [ON], [AUTO] or [OFF]. (☞ pg. 56)

To check the file information

Press **INFO** when playback is paused. (☞ pg. 39)

NOTES:

- The playback picture can be viewed in the LCD monitor or on a connected TV. (☞ pg. 34)
- At the junctions between scenes, the image may stop momentarily or the sound may be interrupted. However, this is not a malfunction.
- When the camera heats up, the  indicator flashes. If the camera continues to heat up, playback may be stopped to protect the recording medium. In this case, turn off the camera power, and then wait until the camera cools down.



Various Operations during Playback

To resume normal playback, press ►II.

Still playback (Pause)



Search playback

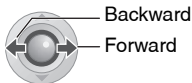

- Pressing </> repeatedly increases the search speed. (-60x to +60x)

Locating the start point of the file or skipping the file

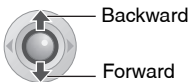

Frame-by-frame playback

While playback is paused



- Pressing </> repeatedly advances or reverses the still picture frame by frame.

Slow motion playback

While playback is paused

Press and hold.



Playback zoom

You can magnify the playback image up to 5x.

While playback is paused

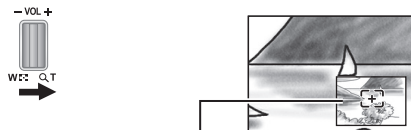

Full view of the image

The ⊕ mark indicates the center point of the magnified area.

- Press ^/~/</> to move to the magnified area you want to view.
- To zoom out, slide the zoom lever towards W.

File Search Function

One-touch operation enables you to switch the index screen to the date index screen or event screen for the convenient file search.

To change the display

On the index screen



Each press switches the screen.



Date Index Screen

You can search the desired file by the recording date.

After displaying the date index screen in “To change the display” (pg. 30)

1 Select the recording date.



2



3 Select the desired file.



- During playback, mark appears on the top left corner of the screen.



Event Screen

You can search the desired file by the event that you registered the file to when recording. (pg. 19) After searching by the event, you can search by the recording date to narrow down the search.

After displaying the event screen in “To change the display” (pg. 30)

1 Select the event.

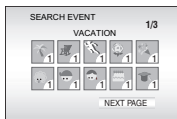

- To move to the next page, select [NEXT PAGE].

2



3 Select the recording date.



- To display all the files, select [ALL SCENES].

4 Select the desired file.



- During playback, ☺E mark appears on the top left corner of the screen.

To change the event registration of a file (pg. 43)

To Play Back Files in the [EXTMOV] Folder

If data cannot be recorded properly, the video files are saved to the [EXTMOV] folder. (pg. 19)

- Press the REC/SNAP button while the index screen is displayed.
- After [MPG] is displayed, press $\wedge/\vee/ </>$ to select the file you want to play, then press \blacktriangleright II.

To return to the index screen

Press the REC/SNAP button again.

- The file information and playlist creation functions are not available for files in the [EXTMOV] folder.
- Delete files in the [EXTMOV] folder by using your PC.

Deleting a Video File

Preparation:

Pause the playback. Alternatively, select the file on the index screen.

1

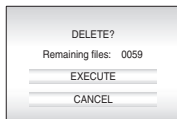

You can select the file that you want to delete by pressing $</>$.

2 Select [EXECUTE].



To exit the file delete screen

Select [CANCEL] in step 2.

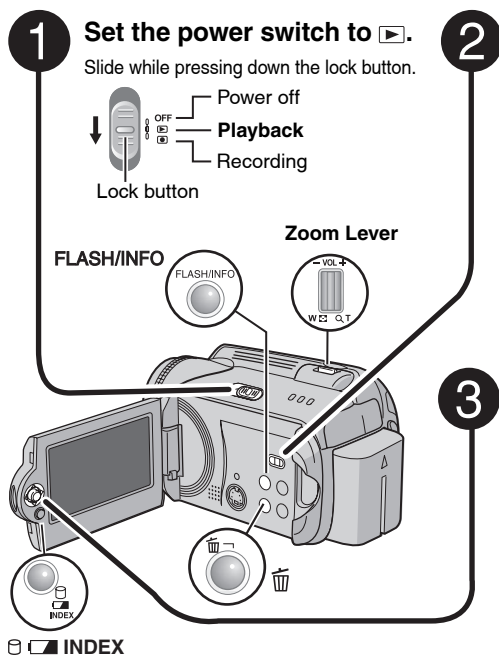

Set the MODE switch to .

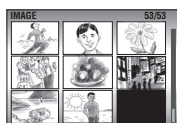
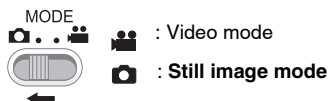

Index screen for still image

- To change the medium to be played back, see page 17.

Press /// to select the desired file, then press .



- Press / to display the previous/next file.

To return to the index screen

Press **INDEX**.

To turn the date/time display on/off

Set [DATE/TIME] to [ON], [AUTO] or [OFF]. (☞ pg. 56)

To check the file information

Press **INFO** when playback is paused. (☞ pg. 39)

File Search Function

One-touch operation enables you to switch the index screen to the date index screen for the convenient file search.

- The event screen cannot be used for still images.

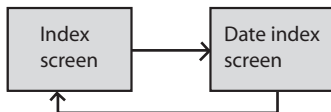

For details on operations, see page 30.



Slide Show

You can playback all the images stored in the recording media automatically.

During playback



- During the slide show, pressing \vee displays files in descending order, and pressing \wedge displays files in ascending order.

To end the slide show

Press $\blacktriangleright \parallel$ again.

Image Rotation

You can rotate a still image clockwise or counterclockwise.

During playback



Counterclockwise

Clockwise

- Each time you press \wedge or \vee , the image rotates ($90^\circ \leftrightarrow 180^\circ \leftrightarrow 270^\circ \leftrightarrow 0^\circ$).

Playback Zoom

You can magnify the playback image up to 5x.

During playback

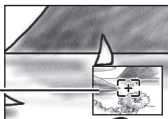

Full view of the image

The \boxtimes mark indicates the center point of the magnified area.

- Press $\wedge / \vee / \langle / \rangle$ to move to the magnified area you want to view.
- To zoom out, slide the zoom lever towards **W**.

Deleting a Still Image File

Preparation:

Playback the still image. Alternatively, select the file on the index screen.

1

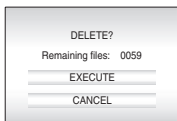

You can select the file that you want to delete by pressing \langle / \rangle .

2 Select [EXECUTE].



To exit the file delete screen

Select [CANCEL] in step 2.

Connecting to a TV, VCR or DVD Recorder

Make sure all units are turned off before connecting.

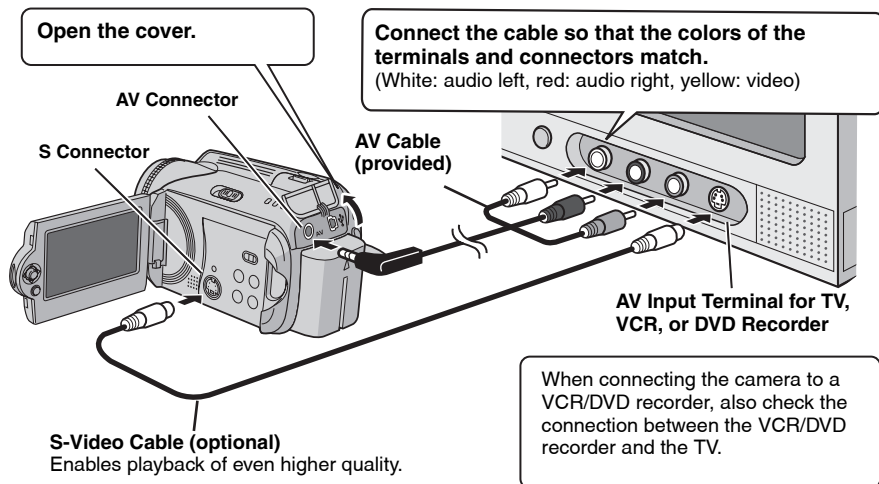

NOTES:

- The S-Video cable is optional. Be sure to use the YTU94146A S-Video cable. Consult the JVC Service Center described on the sheet included in the package for details on its availability. Make sure to connect the end with a core filter to the camera. The core filter reduces interference.
- It is recommended to use the AC adapter as the power supply instead of the battery pack. (▶ pg. 14)
- To connect the camera to a PC, refer to SOFTWARE INSTALLATION AND USB CONNECTION GUIDE.
- This camera is designed to be used with NTSC-type color television signals. It cannot be used with a television of a different standard.
- When using S-video cable, also connect the AV cable.

Playback on TV

After connecting the camera to the TV in "Connecting to a TV, VCR or DVD Recorder" (▶ pg. 34)

- 1 Turn on the camera and the TV.**
- 2 Set the TV to its VIDEO mode.**
- 3 (Only when connecting the camera to the VCR/DVD recorder)**
Turn on the VCR/DVD recorder, and set the VCR/DVD recorder to its AUX input mode.
- 4 Start playback on the camera. (▶ pg. 28, 32)**

NOTE:

If the aspect ratio of the video you are playing is strange and the screen size can be changed on the TV, make adjustments on the TV.

Playback Using the Remote Control

A battery is included inside the remote control at the time of purchase.

Remove the insulation sheet before use.

Beam Effective Area

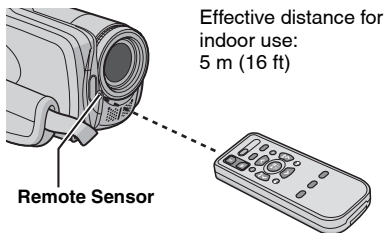

NOTE:

The transmitted beam may not be effective or may cause incorrect operation when the remote sensor is directly exposed to sunlight or powerful lighting.

To Reinsert the Battery

The remote control uses one lithium battery (CR2025).

Pull out the battery holder by pressing the lock tab.

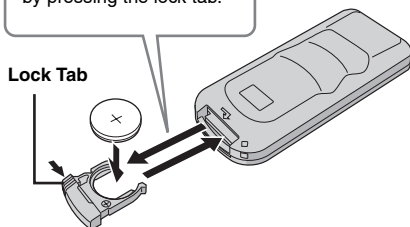

Buttons and Functions

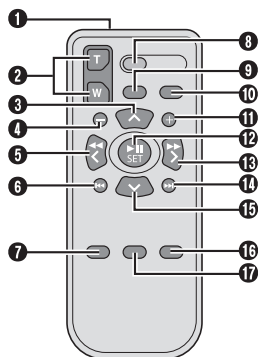

- 1 Infrared Beam Transmitting Window
- 2 ZOOM (T/W) Buttons
Zoom In/Out (⇐ pg. 20, 23)
- 3 Up Button
Rotate Button (counterclockwise) (⇐ pg. 33)
- 4 Skip Backward Button
- 5 Left Button
- 6 Back Button
- 7 PLAYLIST Button (⇐ pg. 44)
- 8 START/STOP Button
- 9 SNAPSHOT Button (⇐ pg. 22)
- 10 INFO Button (⇐ pg. 39)
- 11 Skip Forward Button
- 12 PLAY/PAUSE Button
- 13 Right Button
- 14 Next Button
- 15 Down Button
Rotate Button (clockwise) (⇐ pg. 33)
- 16 INDEX Button
- 17 DATE Button

You can add the following two types of special effects before playback.

Wipe or fader effects

Add effects at the beginning and end of videos. These effects cannot be set for still images.

Playback effects

Add effects that, for example, alter the color tones of videos.

Preparation:

- Set the power switch to .
- Select the file type (video or still image) using the **MODE** switch.

1



2 Select **[WIPE/FADER]** (Video only) or **[EFFECT]**.

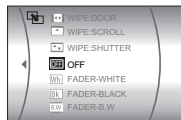

3 Select a desired effect.



For details on each effect, see page 37.

4



Controls in this section

Power Switch



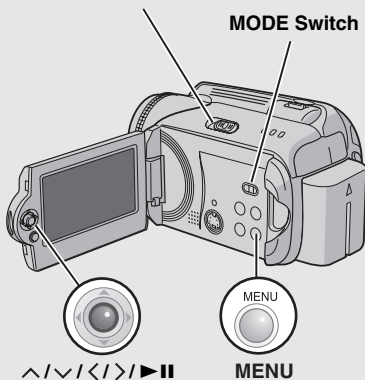





MODE Switch







To turn off the effect

Select **[OFF]** in step 3.

[WIPE/FADER]

Menus	Details
 FADER-WHITE	Fade in or out with a white screen.
 FADER-BLACK	Fade in or out with a black screen.
 FADER-B.W	Fade in to a color screen from a black and white screen, or fade out from color to black and white.
 WIPE:CORNER	Wipe in on a black screen from the upper right to the lower left corner, or wipe out from lower left to upper right, leaving a black screen.
 WIPE:WINDOW	The scene starts in the center of a black screen and wipes in toward the corners, or comes in from the corners, gradually wiping out to the center.
 WIPE:SLIDE	Wipe in from right to left, or wipe out from left to right.
 WIPE:DOOR	Wipe in as the two halves of a black screen open to the left and right, revealing the scene, or wipe out so the black screen reappears from left and right to cover the scene.
 WIPE:SCROLL	The scene wipes in from the bottom to the top of a black screen, or wipes out from top to bottom, leaving a black screen.
 WIPE:SHUTTER	Wipe in from the center of a black screen toward the top and bottom, or wipe out from the top and bottom toward the center leaving a black screen.

[EFFECT]

Menus	Details
 SEPIA	The image is given a brownish tint like an old photo.
 MONOTONE	The image becomes black and white like an old movie.
 CLASSIC FILM*	The image is given an old movie atmosphere by the effect of skipping frames.
 STROBE*	The image looks like a series of consecutive snapshots.

*Not available for still image recording.

You can directly manage recorded files in the camera.

CAUTION:

Do not remove the recording medium or perform any other operation (such as turning off the power) while accessing files. Also, be sure to use the provided AC adapter, as the data on the recording medium may be corrupted if the battery becomes exhausted during operation. If the data on the recording medium becomes corrupted, format the recording medium.

(pg. 41)

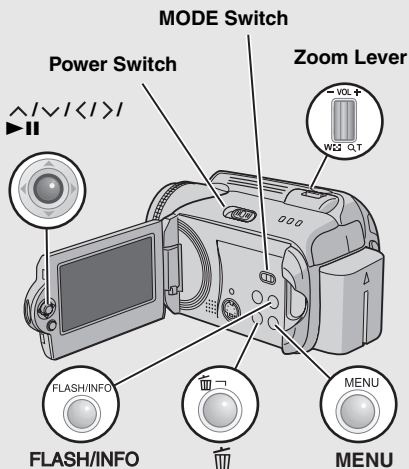
Controls in this section**Deleting Files****Deleting with the Button****Preparation:**

- Set the power switch to .
- Select the file type (video or still image) using the **MODE** switch.

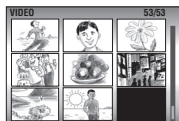
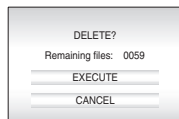
1 Select the file to be deleted.**2**

You can select the file that you want to delete by pressing .

3 Select [EXECUTE].**To exit the file delete screen**

Select [CANCEL] in step **3**.

NOTE:

If you press during recording mode, the file recorded most recently will be deleted. However, if the recording mode (video or still image) is switched or the power is turned off and on again after recording, you cannot delete the file.

Deleting on Menu Screen

Preparation:

- Set the power switch to .
- Select the file type (video or still image) using the **MODE** switch.

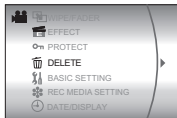
1

2 Select [DELETE].

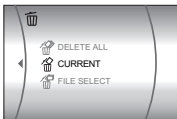

3 Select the desired menu.



- [CURRENT]:**
Currently displayed file is deleted. You can select the previous or next file by pressing \langle / \rangle .
- [FILE SELECT]:**
You can choose multiple files to delete from the index screen.

1) Press $\wedge / \vee / \langle / \rangle$ to select the file you want to delete, then press **▶II**.

- The mark appears on the file. To select other files, repeat this step.
- If you slide the zoom lever towards **T**, the preview screen is displayed. Sliding the zoom lever towards **W** returns to the index screen.

2) Press **MENU**.

- [DELETE ALL]:**
All files are deleted.

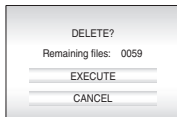

4 Select [EXECUTE].

If [FILE SELECT] was selected in step 3, select [EXECUTE AND QUIT].



NOTES:

- Protected files cannot be deleted. To delete them, release the protection first. (▶ pg. 40)
- Once files are deleted, they cannot be restored. Check files before deleting.

Viewing File Information

Preparation:

- For video files: Pause the playback. Alternatively, select the file on the index screen.
- For still images: Playback the still image. Alternatively, select the file on the index screen.

FLASH/INFO



FILE	: MOV.D0A.MOD
FOLDER	: PRG.001
DATE/TIME	: JAN.1.06 12:00 AM
PB TIME	: 0:20:05
QUALITY	: ULTRA FINE
PROTECT	: OFF

Video Files

FILE: File name

FOLDER: Folder name

DATE/TIME: Date and time of the recording

PB TIME: Playback time (length of the file)

QUALITY: Image quality (▶ pg. 57)

PROTECT: File protection status (▶ pg. 40)

Still Image Files

FILE: File name

FOLDER: Folder name

DATE/TIME: Date and time of the recording

SIZE: Image size (▶ pg. 59)

QUALITY: Image quality (▶ pg. 59)

PROTECT: File protection status (▶ pg. 40)

To turn off the file information display

Press **INFO** again.

Protecting Files from Accidental Erasure

Preparation:

- Set the power switch to .
- Select the file type (video or still image) using the **MODE** switch.

1

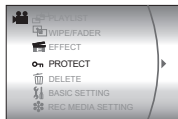

2 Select [PROTECT].

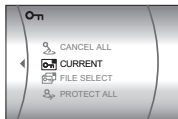

3 Select the desired menu.



- **[CURRENT]:**

Currently displayed file is protected. You can select the previous or next file by pressing $\langle \rangle$.

- **[FILE SELECT]:**

You can choose multiple files to protect from index screen.

1) Press $\wedge / \vee / \langle / \rangle$ to select the file you want to protect, then press **▶II**.

- The  mark appears on the file. To select other files, repeat this step.
- If you slide the zoom lever towards **T**, the preview screen is displayed. Sliding the zoom lever towards **W** returns to the index screen.

2) Press **MENU**.

- **[PROTECT ALL]:**

All files are protected.



4 Select [EXECUTE].

If [FILE SELECT] was selected in step 3, select [QUIT].



To release protection

Select the protected file in step 3.

To release protection of all files

- 1) In step 3, select [CANCEL ALL], then press **▶II**.
- 2) Press \wedge / \vee to select [EXECUTE], then press **▶II**.

NOTE:

For an SD card, you can use the write/erase protection tab to set protection. To protect all the files, slide the tab to the "LOCK" position.

Write/erase protection tab



Formatting a Recording Medium

You can format (initialize) the built-in hard disk (HDD) or SD cards. You have to format newly-purchased SD cards with this camera before using them. This will also ensure stable speeds and operation when accessing the recording medium. Be aware that all files and data including protected files will be erased by the formatting process.

Preparation:

- Set the power switch to or .



2 Select [REC MEDIA SETTING].

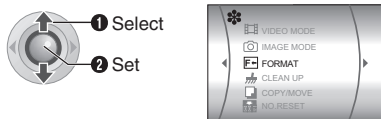

3 Select [FORMAT].

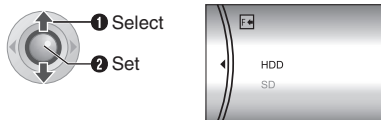

4 Select [HDD] or [SD].

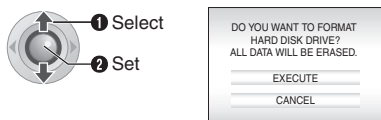

5 Select [EXECUTE].



To make it more difficult to recover the data on the hard disk

Even if you format the hard disk or erase the data on the hard disk, sometimes the erased data can be recovered by using data recovery software etc. that are commercially available. By pressing while selecting [HDD] and holding down the button in step 4, you can erase the data on the hard disk in a format that is difficult to recover. Moreover, by repeating this procedure, you can make the data even more difficult to recover.

- When formatting in this way, a formatting progress bar is displayed.
- If the formatting progress bar does not appear, select [CANCEL] and try again from step 3.



NOTE:

Do not format the recording medium on your PC. Make sure that you format the recording medium on the camera.

Cleaning Up a Recording Medium

Writing speed of recording media tends to become slow after long periods of repeated use. To regain the speed, execute cleanup periodically. The cleanup function is equivalent to a PC's "Defragmentation" function.

Preparation:

- Set the power switch to  or .
- Be sure to use the provided AC adapter for the power supply when cleaning up a recording medium. (➡ pg. 14)



- 2 Select and set items as follows.
[REC MEDIA SETTING] → [CLEAN UP]

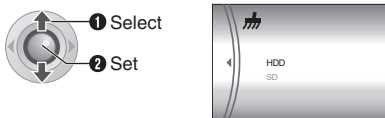

- 3 Select [HDD] or [SD].



- 4 Select [EXECUTE].





- When cleanup is finished, [CLEANING UP COMPLETED] appears. Press  to complete the operation.
- Depending on the hard disk drive it may take several minutes for the cleanup process to be completed.

Resetting the File Number

By resetting the file number (name), a new folder will be made. The new files you are going to make will be stored in the new folder. It is convenient to separate the new files from previously recorded files.

Preparation:

- Set the power switch to  or .



- 2 Select and set items as follows.
[REC MEDIA SETTING] → [NO.RESET]



- 3 Select the file type ([VIDEO] or [IMAGE]).

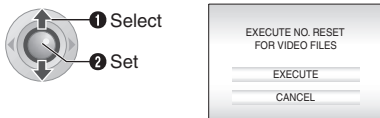



- 4 Select [EXECUTE].



Changing the Event Registration of Video Files after Recording

Preparation:

- Set the power switch to .
- Set the **MODE** switch to .

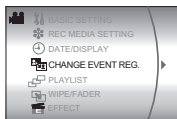
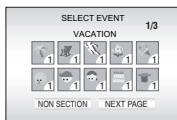
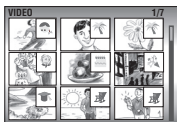
1

2 Select **[CHANGE EVENT REG.]**.

3 Select a new event to register the file to.

- To move to the next page, select **[NEXT PAGE]**.
- To cancel the event registration, select **[NON SECTION]**.

4 Select the file you want to register.

- The **✓** mark appears on the file. To select other files, repeat this step.
- If you slide the zoom lever towards **T**, the preview screen is displayed. Sliding the zoom lever towards **W** returns to the index screen.

5



6 Select **[SAVE AND QUIT]**.

What is a Playlist?

It is a list that enables you to organize recorded videos in order of preference.

To display the playlist screen

Preparation:

- Set the power switch to .
- Set the MODE switch to .

1

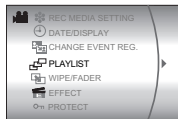

2 Select [PLAYLIST].

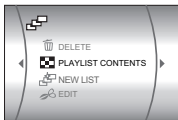

NOTE:

You can display the playlist menu simply by pressing the PLAYLIST button on the remote control.

Controls in this section

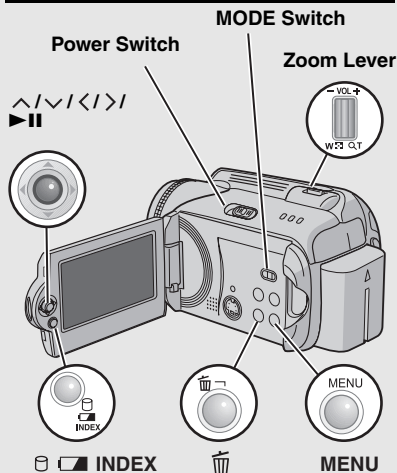

Creating Playlists

After performing "To display the playlist screen" (pg. 44)

3 Select [NEW LIST].



4 Select an item and display files.



- **[IMPORT FROM EVENT]:**
Search for an event and display the corresponding files listed by recording date. Press \wedge / \vee / \langle / \rangle to select the event, then press **▶II**.
- **[IMPORT FROM DATE]:**
Display all the files in the medium listed by recording date.
- **[ALL SCENES]:**
Display all files individually.

The files are displayed.

See "Displaying Files" (pg. 45) for details.

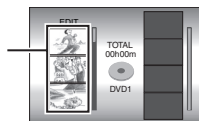

5 Select the file to add to playlist.

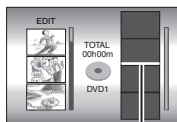

Insertion point

6 Select the insertion point.

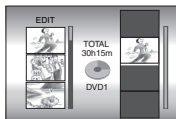

- To add other files, repeat steps 5 and 6.

7

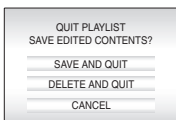

8 Select [SAVE AND QUIT].



To check a registered scene

- 1) Press **>** after step 6 to move to the registered file column shown on the right.
- 2) Use **^**/**v** to select a file and press **▶||**.
- 3) Press **INDEX** to return to the previous screen.

To delete a registered scene

- 1) Press **>** after step 6 to move to the registered file column shown on the right.
- 2) Use **^**/**v** to select a file and press **🗑**.

NOTES:

- A maximum of 99 playlists can be created.
- Each playlist can consist of a maximum of 99 scenes.
- If you delete the original files, the corresponding files are also deleted from the playlist.
- Files in the [EXTMOV] folder cannot be used to create playlists.

Displaying Files

Details on how files are displayed in step 4 are described below.

When selecting [IMPORT FROM EVENT] or [IMPORT FROM DATE]

All the files recorded on the same date are displayed as a single file. Originally, these files cannot be registered separately. To register files separately, perform "Adding/Deleting Files in Playlist" (pg. 46) after creating the playlist.

Recording date: March 12, 2006

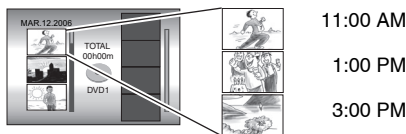

To check individual scenes

Use **^**/**v** to select the file and press the **INDEX** button. A list of individual scenes appears.

- To display the preview screen, select a file and press **▶||**. Press again to return to the previous screen.
- Press **INDEX** again to stop checking.

When selecting [ALL SCENES]

Files can be displayed individually and registered in order of preference.

Recording date: March 12, 2006

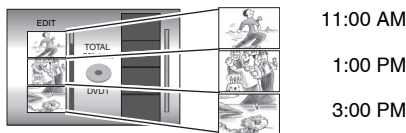



Playing Back Playlists

After performing “To display the playlist screen” (☞ pg. 44)

3 Select [PLAYLIST CONTENTS].

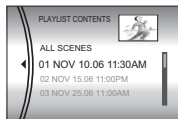

4 Select the playlist that you want to playback.



- During playback of the playlist, **P** mark appears on the top left corner of the screen.
- If you slide the zoom lever towards **W** while playback is paused, the index screen for playlist appears. You can see the contents of the playlist and select the desired scene. To return to the playback screen, slide the zoom lever to **T**.

To stop playback

Press **▶II**.

To return to the normal playback mode

Select [ALL SCENES] in step 4.

Other Operations of Playlists

You can perform additional editing and delete files in a created playlist.

Preparation:

Perform “To display the playlist screen” (☞ pg. 44).

Adding/Deleting Files in Playlist

3 Press **^/∨** to select [EDIT], then press **▶II**.

4 Press **^/∨** to select the playlist you want to edit, then press **▶II**.

- To add or delete files, follow the steps 5 to 8 in “Creating Playlists” (☞ pg. 44).

Changing Playlist Names

The default name of a playlist is its creation date and time.

3 Press **^/∨** to select [RENAME], then press **▶II**.

4 Press **^/∨** to select the desired playlist, then press **▶II**.

5 Press **^/∨/⟨/⟩** to select the desired letter, then press **▶II**.

- Repeat this process to complete the name.
- You can change the character types (capital letters, small letters or marks) by selecting [A/a/@].
- To correct a letter, select [←] or [→] and press **▶II** to move the cursor to the letter, then select [CLEAR] and press **▶II**.

6 Press **^/∨/⟨/⟩** to select [←], then press **▶II**.

Deleting Playlist

Original files are not deleted even if you delete the playlist.

3 Press **^/∨** to select [DELETE], then press **▶II**.

4 Press **^/∨** to select a playlist you want to delete.

- To delete all playlists at once, select [DELETE ALL].

5 Press **▶II**.

6 Press **^/∨** to select [EXECUTE], then press **▶II**.

**DPOF Print Setting**

This camera is compatible with DPOF (Digital Print Order Format). You can set which images to be printed and the number of prints with this camera. This feature is useful to print with a DPOF-compatible printer or for taking the recording medium to a photo lab for printing.

Preparation:

- Set the power switch to
- Set the **MODE** switch to

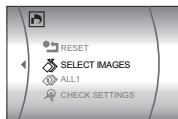
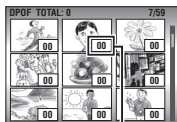
**2 Select [DPOF].****3 Select [SELECT IMAGES].****Number of prints****4 Select the desired file.**

- If you slide and hold the zoom lever towards **T**, the preview screen of the still image is displayed.

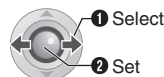
5 Select the number of prints.

- To set print information for other images, repeat steps **4** and **5**. (You can set up to 999 files.)

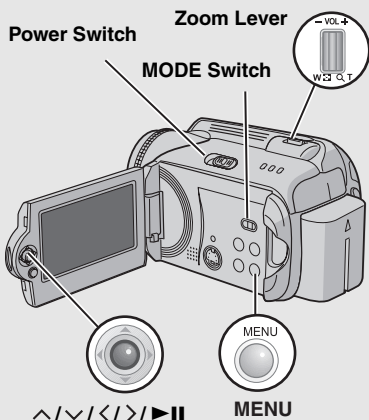
**Controls in this section****To cancel the selection**

Set the number of prints to "00".

To print all still images (One print for each)

- 1) In step **3**, press to select [ALL1], then press .
- 2) Press to select [EXECUTE], then press .

To confirm DPOF settings

In step **3**, press to select [CHECK SETTINGS], then press .

- If necessary, change the number of prints for the desired file by following steps **4** and **5**.

To reset DPOF settings

- 1) In step **3**, press to select [RESET], then press .
- 2) Press to select [EXECUTE], then press .



Direct Printing with PictBridge Printer

If your printer is compatible with PictBridge, still images can be printed easily by connecting the camera directly to the printer with the USB cable. DPOF setting can also be used. (☞ pg. 47)

To Print by Selecting a Still Image

Preparation:

- Set the power switch to .
- Set the MODE switch to .

1



2 Select [DIRECT PRINT].



- [PLEASE CONNECT PRINTER] appears.

3 Connect the camera to the printer with the USB cable.

- After a while, the print menu appears.

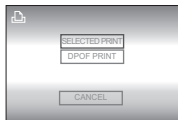

4 Select [SELECTED PRINT].



5 Select the desired Image.

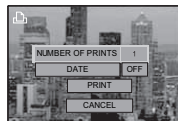
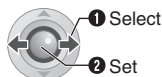

6 Press \wedge/\vee to select menus and press \langle/\rangle to select settings.



- **[NUMBER OF PRINTS]:**
The number of prints can be set from 1 to 99.
- **[DATE]:**
Set whether to print the date and time.

7 Select [PRINT].



To stop printing after printing starts

- 1) Press \blacktriangleright II.
- 2) Press \wedge/\vee to select [EXECUTE], then press \blacktriangleright II.

NOTE:

If the printer is not recognized, or to print again after direct printing with a PictBridge printer, remove the USB cable, select [DIRECT PRINT] in the menu again, and then reconnect the cable.

To Print Using the DPOF Settings

If the printer is compatible with DPOF, you can use the DPOF settings. (☞ pg. 47)

After performing step 1-3

4 Select and set items as follows. [DPOF PRINT] \rightarrow [PRINT]



- To confirm the DPOF setting, press \wedge/\vee to select [CHECK SETTINGS], then press \blacktriangleright II. After that, press MENU to return to the previous menu.

Using a DVD Burner for Dubbing (DVD Creation Function) (Continued)

4 Select an item and display the DVD Creation List for the files to be dubbed.



- **[SELECT FROM EVENT]:**
Search for an event and display the corresponding files listed by recording date. Press \wedge / \vee / \langle / \rangle to select the event, then press **▶II**.
- **[SELECT FROM DATE]:**
Display the files recorded on selected dates listed by recording date. Press \wedge / \vee to select the recording date, then press **▶II**.
- **[SELECT FROM PLAYLIST]:**
Register a created playlist. Playlists are displayed in a list in the selection order.
1) Press \wedge / \vee to select the desired list, then press **▶II**. To select other lists, repeat this process.
2) Press \rangle .
- **[SELECT FROM HISTORY]:**
Create a DVD disc identical to the one created last time. The last creation date is displayed. (Up to 20 files)
Press \wedge / \vee to select the date, then press **▶II**.
- **[ALL SCENES]:**
Display all files individually.

Files for dubbing are displayed.

Disc number

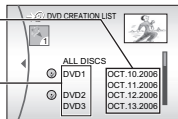

Make sure to read “DVD Creation List” (pg. 51) before proceeding to the next procedure.

5 Select the desired disc number.



- If you select [ALL DISCS], all discs in the list are created.
- **To check individual files**
Use \wedge / \vee to select the file number and press the **INDEX** button. A list of individual scenes appears.
 - To display the preview screen, select a file and press **▶II**. Press again to return to the previous screen.
 - Press **INDEX** again to stop checking.

6

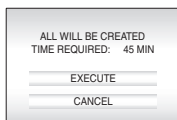

7 Select [EXECUTE].



- The DVD disc begins to be created.
- When [COMPLETED. CHANGE DISC] appears, change the disc. The second DVD disc begins to be created.

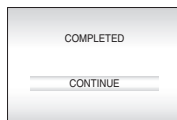

8



- To continue creating DVD discs, select [CONTINUE] and press **▶II**.

To check whether the DVD disc was created properly

Select [PLAY DVD] in the screen that appears in step 3 and press **▶II**.

You can also playback DVD on the TV by connecting the camera with the audio/video cable.

Press **INDEX** to stop checking.



DVD Creation List

Displaying Files for Dubbing

Files for dubbing can be displayed in two ways shown below.

Displaying file by recording date or playlist

Multiple files are displayed as a single file.

Recording date: Oct. 10, 2006

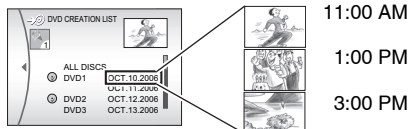

Displaying file individually

Files are displayed individually.

Recording date: Oct. 10, 2006

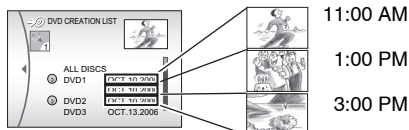

Menu for Disc Playback

DVD discs created with the camera can be played on compatible DVD players or other devices.

- An individual date or individual playlist becomes one title.
- The discs are configured so that playback begins automatically when they are inserted in devices.
- To display the top menu, press the corresponding menu button of the other device.

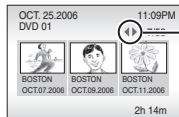

To display other pages, use these arrows.

Disc Number

Disc number shows the number of DVD discs you can create. The dubbing range of each disc is automatically allocated, presuming that all the files are to be dubbed from the first one on the list. This dubbing range cannot be changed.

ex.) "DVD1" records 2 files, "OCT.10.2006" and "OCT.11.2006".

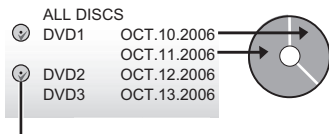

Mark that shows that the disc is created already.



Using a VCR/DVD Recorder for Dubbing

Preparation:

Connect the camera to a VCR or DVD recorder.
(☞ pg. 34)

1 Set the VCR/DVD recorder to its AUX input mode.

2 Start playback on the camera.

- To playback videos (☞ pg. 28)
- To playback playlists (☞ pg. 46)

3 At the point you want to start dubbing, start recording on the VCR/DVD recorder.

(Refer to the VCR/DVD recorder's instruction manual.)

To stop dubbing

Stop recording on the VCR/DVD recorder, then stop playback on the camera.



Check which buttons to use in the illustration of “Controls in this section” on page 49.

You can copy or move still image files between the HDD and SD card using the on-screen display.

Preparation:

- Set the power switch to or .
- Make sure that SD card is inserted in the SD slot.
- Make sure that enough free space is left in the copy/move destination medium.

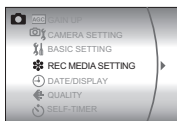
1

2 Select and set items as follows.

[REC MEDIA SETTING] → [COPY/ MOVE]

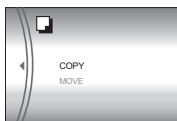

3 Select the desired menu.



- **[COPY]:** Files are copied to the destination medium while leaving original files in the source medium.
- **[MOVE]:** Files are moved to the destination medium while deleting original files (except read-only files) in the source medium.

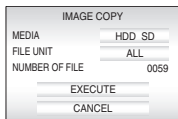

4 Set the direction of copy/move. (HDD → SD or SD → HDD)

5

6 Set the file unit ([ALL] or [FILE]) to copy/move.



• [FILE]:

Select when you want to transfer the selected files.

1) Press $\wedge/\vee/\langle/\rangle$ to select the desired file, then press \blacktriangleright .

- The \checkmark mark appears on the file. To select other files, repeat this step.

2) Press **MENU**.

• [ALL]:

Select when you want to transfer all files in the recording medium.

7 Select [EXECUTE].



- File transfer starts. When [COPYING (MOVING) COMPLETED] appears, press \blacktriangleright .





To stop the file transfer

Press \blacktriangleright , then select [EXECUTE] and press \blacktriangleright .

You can change the menu settings to customize your camera.

- Some menus can be used for both operation modes (recording/playback) and file types (video/still image). Other menus can be used depending on the selected file type and operation mode.
- To see all the menus, scroll the screen.

Preparation:

- Select  (recording) or  (playback) using the power switch.
- Select  (video) or  (still image) using the **MODE** switch.

1

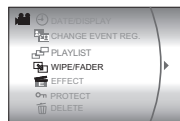

2 Select the desired menu.



For details on each menu, see pages 55 to 59.

3 Select the desired menu setting.



To return to the previous screen

Press .

To return to the normal screen

Press **MENU**.

To display the operation guide

Press **INFO** when the menu screen is displayed. (The operation guide is not displayed depending on the type of the menu.) To remove the operation guide, press **INFO** again.



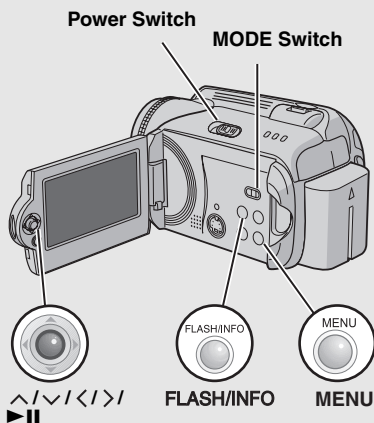



Controls in this section















NOTE:

Even if the menu item is displayed, some items cannot be set depending on the selected mode (video/still image, recording/playback). In this case, sub menus cannot be accessed and settings cannot be changed.

Common Menus for All Modes

Menu	Settings ([] = Factory-preset)	
 BASIC SETTING	Press ► and then select sub menus.	—
 PRESET Returns all the camera settings to their default values.	EXECUTE: Performs this function. [CANCEL]: Returns to the menu screen without executing reset.	—
 DEMO MODE Introduces special features of the camera at the following cases. ● When the menu screen is closed. ● When there is no operation for about 3 minutes after the power switch is set to  .	OFF: Disables the function. [ON]: Activates the function. NOTES: ● The demonstration only works when the DC cord is connected, not with the battery. ● If an SD card is in the camera, demonstration will not take place even if this mode is set to [ON].	—
 OPERATION SOUND Enables you to set the operation sound or turn the operation sound on/off.	OFF: Turns off the operation sound. BEEP: The beep sounds when the power is turned on or off, and at the beginning and end of recording. [MELODY]: Instead of a beep, a melody sounds when any operation is performed.	—
 REMOTE Turns reception of the operation signal from the remote control on/off.	OFF: The camera does not receive the signal from the remote control. [ON]: Enables operation with the remote control.	—
 DROP DETECTION Setting this function helps prevent damage to the HDD by enabling the camera to turn off the power automatically when, for example, it detects that it has been dropped.	OFF: Disables the function. [ON]: Activates the function. To turn the unit on when the drop detection worked, set the power switch to OFF , and to on again. CAUTION: Setting this function to off increases the chances of damaging the built-in hard disk if the camera is accidentally dropped.	—

Common Menus for All Modes (Continued)







Menus	Settings ([] = Factory-preset)	
 REC MEDIA SETTING	Press ▶II and then select sub menus.	—
 VIDEO MODE Enables you to set the recording medium for videos.	[HDD] / SD	17
 IMAGE MODE Enables you to set the recording medium for still images.	[HDD] / SD	17
 FORMAT Enables you to select the medium to format.	[HDD] / SD	41
 CLEAN UP Enables you to select the medium to clean up.	[HDD] / SD	42
 COPY/MOVE Enables you to set whether to duplicate or move still images during dubbing.	[COPY] / MOVE	53
 NO. RESET Enables you to select the file type (videos or still images) when resetting the file number.	[VIDEO] / IMAGE	42
 DATE/DISPLAY	Press ▶II and then select sub menus.	—
 BRIGHT Enables you to set the brightness of the LCD monitor.	Adjust the brightness of the display using </> , then press ▶II .	—
 DATE/TIME Enables you to set whether to display the current time on the LCD monitor.	<p>OFF: The date/time does not appear.</p> <p>[AUTO]: The date/time appears for approx. 5 seconds in the following cases.</p> <ul style="list-style-type: none"> ●When the power switch is set from OFF to  ●When playback starts ●When the date is changed during playback <p>ON: The date/time is always displayed.</p> <p>NOTE: You can set different settings for each mode (video recording/playback and still image recording/playback).</p>	—
 SCENE COUNTER Enables you to set whether to display the counter in video mode.	<p>[OFF]: Disables the function.</p> <p>ON: Activates the function.</p>	—
 LANGUAGE Enables you to set the language for menus.	[ENGLISH] / FRANÇAIS / ESPAÑOL / PORTUGUÉS / 日本語 / 한국어 / 中文	15

Menus	Settings ([] = Factory-preset)	
CLOCK ADJUST Enables you to set the time.	DATE / TIME	15
DATE DISPLAY ORDER Enables you to set the date and time display format.	DATE ORDER: year.month.day / [month.day.year] / day.month.year TIME: 24H / [12H]	-
DISPLAY	OFF: Turns off the on-screen display. [ON]: Turns on the on-screen display.	-







Video Recording Menus

Menus	Settings ([] = Factory-preset)	
REGISTER EVENT Enables you to turn on/off event registration for any videos before starting recording.	ON/SELECT: Activates the function. After you activate this function, you can select the event to register videos to. [OFF]: Disables the function.	19
QUALITY Enables you to set the picture quality for videos.	[ULTRA FINE] / FINE / NORMAL / ECONOMY	-
WIND CUT Reduces noise caused by wind.	[OFF]: Disables the function. ON: Activates the function.	-
GAIN UP Makes the subject appear bright automatically when you record in dark places. However, the overall color tones appear grayish.	OFF: Disables the function. [ON]: Activates the function.	-
DIS Compensates for hand shake.	OFF: Disables the function. [ON]: Activates the function. NOTES: <ul style="list-style-type: none"> • Accurate stabilization may not be possible if hand shake is excessive, or depending on the shooting conditions. In this case, the indicator blinks or goes out. • Switch off this mode when recording with the camera on a tripod. 	-
CAMERA SETTING	Press ▶II and then select sub menus.	-
ZOOM Enables you to set the maximum zoom ratio.	10X: Only optical zoom is available up to 10x. [40X]: Digital zoom is available up to 40x. 300X: Digital zoom is available up to 300x.	20
TELE MACRO You can shoot a subject as large as possible at a distance of approx. 40 cm (1.3 ft).	[OFF]: Disables the function. ON: Activates the function.	-





Video Playback Menus

Menus	Settings ([] = Factory-preset)	
 CHANGE EVENT REG. Enables you to change the event registration of recorded video files.	BABY / BIRTHDAY / VACATION / HOLIDAY / SPORTS / GRADUATION / ANNIVERSARY / DAUGHTER / SON / CONGRATULATIONS / NON SECTION	43
 PLAYLIST Enables you to perform operations related to playlists.	[PLAYLIST CONTENTS] / NEW LIST / EDIT / RENAME / DELETE	44
 WIPE/FADER These are special playback effects. They add effects to the beginning and end of playback.	[OFF] / FADER-WHITE / FADER-BLACK / FADER-B.W / WIPE:CORNER / WIPE:WINDOW / WIPE:SLIDE / WIPE:DOOR / WIPE:SCROLL / WIPE:SHUTTER	36
 EFFECT These are special playback effects. They add effects that alter color tones.	[OFF] / SEPIA / MONOTONE / CLASSIC FILM / STROBE	36
 PROTECT Enables you to perform operations related to protecting files.	[CURRENT] / FILE SELECT / PROTECT ALL / CANCEL ALL	40
 DELETE Enables you to perform operations related to deleting files.	[CURRENT] / FILE SELECT / DELETE ALL	39

Still Image Recording Menus

Menus	Settings ([] = Factory-preset)	
 QUALITY Enables you to set the picture quality for still images.	[FINE] / STANDARD	–
 IMAGE SIZE Enables you to select the picture size for still images.	[1632 x 1224] / 1280 x 960 / 1024 x 768 / 640 x 480	–
 SELF-TIMER This is the timer function. It starts recording when the set time elapses after the REC/SNAP button is pressed.	[OFF] / 2SEC / 10SEC	–
 CONTINUOUS SHOOTING This is the continuous shooting function. It records still images continuously while the REC/SNAP button is pressed.	[OFF]: Disables the function. [ON]: Activates the function.	23
 GAIN You can set the ISO setting to increase the sensitivity in dark conditions.	[AUTO] / 100 / 200	–
 CAMERA SETTING	Press ► and then select sub menus.	–
 TELE MACRO You can shoot a subject as large as possible at a distance of approx. 40 cm (1.3 ft).	[OFF]: Disables the function. [ON]: Activates the function.	–

Still Image Playback Menus

Menus	Settings ([] = Factory-preset)	
 DPOF Enables you to configure settings related to DPOF.	SELECT IMAGES / ALL1 / CHECK SETTINGS / RESET	47
 DIRECT PRINT Enables you to configure settings related to printing.	After you select this menu, connect the camera to a printer with the USB cable.	48
 EFFECT These are special playback effects. They add effects that alter color tones.	[OFF] / SEPIA / MONOTONE	36
 PROTECT Enables you to perform operations related to protecting files.	[CURRENT] / FILE SELECT / PROTECT ALL / CANCEL ALL	40
 DELETE Enables you to perform operations related to deleting files.	[CURRENT] / FILE SELECT / DELETE ALL	39

The camera is a microcomputer-controlled device. External noise and interference (from a TV, a radio, etc.) might prevent it from functioning properly.

- To solve the problem, first follow the instructions below.
- If the problem is not solved, reset the camera. (➡ right column)
- If the problem persists, please consult your nearest JVC dealer.

To reset the camera

- 1) Press **RESET** using a piece of wire or other pointed instrument. The power is turned off once and turned on again automatically.

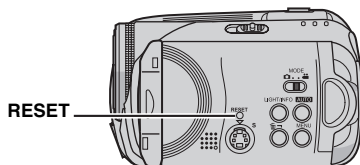

- 2) If nothing happens, set the power switch to **OFF** and remove the power supply (battery pack or AC adapter) from the camera, then reattach it.
- 3) Execute [PRESET] from the menu. The camera returns to its factory-preset. (➡ pg. 55)



Trouble	Action	➡
Power		
No power is supplied.	<ul style="list-style-type: none"> ● Connect the AC adapter securely. ● Detach the battery pack once again and re-attach it firmly. ● Replace the dead battery with a fully charged one. 	14 14 —
No display appears.	<ul style="list-style-type: none"> ● When using the AC adapter, the camera enters the sleep mode, the access lamp lights, and the LCD monitor turns off. To cancel the sleep mode, perform any operation such as zooming. 	—
The power was turned off accidentally.	<ul style="list-style-type: none"> ● The drop detection function operated. Set the power switch to OFF, and turn the power on again. To turn off the drop detection function, set [DROP DETECTION] to [OFF]. 	55

Trouble	Action	
Displays		
The power/charge lamp on the camera does not light during charging.	<ul style="list-style-type: none"> Charging is difficult in places subject to extremely high/low temperatures. To protect the battery, it is recommended to charge it in places with a temperature of 10°C to 35°C (50°F to 95°F). When the battery is already fully charged, the lamp does not light. Check the remaining battery power. 	– 16
[SET DATE/TIME!] appears.	<ul style="list-style-type: none"> The built-in clock's rechargeable lithium battery is discharged, so the previously set date/time is erased. Connect the camera to an AC outlet using the AC adapter for over 24 hours to charge the clock's lithium battery. Then set the date/time. 	14 15
Images on the LCD monitor appear dark or whitish.	<ul style="list-style-type: none"> Adjust the brightness and angle of the LCD monitor. When the LCD monitor's LED light reaches the end of its service life, images on the LCD monitor become dark. Consult your nearest JVC dealer. 	56 –
Colored bright spots appear on the LCD monitor.	<ul style="list-style-type: none"> The LCD monitor is made with high precision technology. However, black spots or bright spots of light (red, green or blue) may appear constantly on the LCD monitor. These spots are not recorded on the picture. This is not due to any defect of the unit. (Effective dots: more than 99.99 %) 	–
Image does not appear on the LCD monitor.	<ul style="list-style-type: none"> Adjust the brightness of the LCD monitor. 	56
Image appears to be slightly vertically stretched when playing back on a 4:3 screen TV.	<ul style="list-style-type: none"> Such a phenomenon will occur if the image is recorded at 16:9 mode. Record videos at 4:3 mode if playing back on a 4:3 screen TV. 	20
Recording		
Recording cannot be performed.	<ul style="list-style-type: none"> Replace with new recording medium or delete unnecessary files. Select the recording medium properly. 	38 17
When shooting a subject illuminated by bright light, vertical lines appear.	<ul style="list-style-type: none"> This is not a malfunction. 	–
When the screen is under direct sunlight during shooting, the screen becomes red or black for an instant.	<ul style="list-style-type: none"> This is not a malfunction. 	–
During recording, the date/time does not appear.	<ul style="list-style-type: none"> Set [DATE/TIME] to [ON]. 	56

Trouble	Action	
Recording (Continued)		
The LCD monitor indications blink.	<ul style="list-style-type: none"> ● Certain modes of program AE, effect, DIS, and other functions that cannot be used together are selected at the same time. 	—
Digital zoom does not work.	<ul style="list-style-type: none"> ● Set [ZOOM] to [40X] or [300X]. ● Digital zoom is not available in the still image recording mode. 	57 —
The recorded image is white.	<ul style="list-style-type: none"> ● In bright places, setting "Nightalive" or a slow speed is not recommended. 	26
The focus is not adjusted automatically.	<ul style="list-style-type: none"> ● Set focus to the automatic mode. ● Clean the lens and check the focus again. 	25 66
The color of the image looks strange.	<ul style="list-style-type: none"> ● Try manual white balance adjustment. 	25
The recorded image is too dark.	<ul style="list-style-type: none"> ● Try backlight compensation or manual exposure. 	25 27
The recorded image is too bright.	<ul style="list-style-type: none"> ● Try manual exposure. 	25
White balance setting cannot be activated.	<ul style="list-style-type: none"> ● Do not select the sepia (SEPIA) or monotone (MONOTONE) mode before setting white balance. 	26
The continuous shooting speed of still images is slow.	<ul style="list-style-type: none"> ● The continuous shooting speed will drop when repeatedly making continuous shots, when using certain recording media, or under certain recording conditions. 	—
Playback		
Playback cannot be performed.	<ul style="list-style-type: none"> ● Select the recording medium properly. ● To watch images on a TV, set the TV's input mode or channel that is appropriate for video playback. 	17 34
The same image is displayed for a long time during video playback, or motion is choppy.	<ul style="list-style-type: none"> ● The surface of the disk or card is damaged. It is recommended to run check disk regularly on the PC, providing that there is no data on the hard disk of the camera. 	—
The black & white fader does not work.	<ul style="list-style-type: none"> ● Do not select the sepia (SEPIA) or monotone (MONOTONE) mode. 	37
There is a noise during playback.	<ul style="list-style-type: none"> ● The sound of the hard disk drive may have been recorded if the camera was moved suddenly during recording. Do not move or shake the camera suddenly during recording. 	—

Trouble	Action	
Editing / Printing		
Files cannot be deleted.	<ul style="list-style-type: none"> Remove protection from the files and delete them. 	40
When the image is printed from the printer, a black bar appears at the bottom of the screen.	<ul style="list-style-type: none"> This is not a malfunction. This can be avoided by recording with DIS activated. 	57
Other problems		
The data process is too slow after the power is switched on or the mode is changed.	<ul style="list-style-type: none"> There is a large number of still images (approx. 1,000 or more) stored in the recording medium. Copy the stored files to a PC, and delete them from the recording medium. 	38
The SD card cannot be removed from the camera.	<ul style="list-style-type: none"> Push the SD card in a few more times. 	17

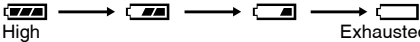
The following indications appear on the screen.

Indication	Meaning	
 (Battery indicator)	<ul style="list-style-type: none"> Displays the remaining battery power. Remaining power level  <ul style="list-style-type: none"> As the battery power comes close to nil, the battery indicator blinks. When the battery power is exhausted, power turns off automatically. 	<p>–</p> <p>–</p>
SET DATE/TIME!	<ul style="list-style-type: none"> Appears when the date/time is not set. Appears when the built-in clock (lithium) battery is discharged and the previously set date/time is erased. 	<p>15</p> <p>61</p>
LENS CAP	<ul style="list-style-type: none"> Appears for 5 seconds after power is turned on with the power switch set to  if the lens cap is attached or when it is dark. 	<p>–</p>
PLEASE INSERT MEMORY CARD!	<ul style="list-style-type: none"> Appears when there is no SD card inserted in the SD slot. 	<p>17</p>
HARD DISK DRIVE IS NOT FORMATTED	<ul style="list-style-type: none"> Appears when the built-in hard disk needs to be formatted. 	<p>41</p>
THIS CARD IS NOT FORMATTED	<ul style="list-style-type: none"> Appears when an unformatted SD card is inserted. 	<p>41</p>
HDD ERROR! MEMORY CARD ERROR!	<ul style="list-style-type: none"> Appears when some errors occurred with the recording media. Remove the card once and insert it again. If the error is not cancelled, replace the card with one that has been guaranteed for correct operation. Perform clean up to restore the capacity of the recording media. It is recommended to run check disk regularly on the PC, providing that there is no data on the hard disk of the camera. 	<p>–</p> <p>17</p> <p>42</p> <p>–</p>
CHECK CARD'S WRITE PROTECTION SWITCH	<ul style="list-style-type: none"> Appears when you attempt recording when the write/erase protection tab on the SD card is set to the "LOCK" position. 	<p>40</p>
NO VIDEO FILES STORED!	<ul style="list-style-type: none"> Appears if there are no video files when you attempt video playback. 	<p>–</p>
NO IMAGE FILES STORED!	<ul style="list-style-type: none"> Appears if there are no still image files when you attempt still image playback. 	<p>–</p>
NO MEMORY CARD	<ul style="list-style-type: none"> Appears when the SD card is not inserted to the SD slot for file copy/move operation. 	<p>–</p>
NO SUPPORTED FILES	<ul style="list-style-type: none"> Appears when there are no JPEG (still image) files to be copied or moved in recording media. 	<p>–</p>

Indication	Meaning	
NUMBER OF FOLDERS OVERFLOW	● Appears when the number of folders exceeds the limit for file copy/move operation.	-
MEMORY CARD ERROR! REINSERT CARD OR CHANGE CARD.	● Appears when the camera does not recognize the loaded SD card. Remove the card once and insert it again or replace with another card.	17
FILE SYSTEM MAY HAVE PROBLEM. FORMAT IS RECOMMENDED AFTER COPYING WANTED DATA.	● The file system of the recording medium may have a problem. It is recommended to copy the data for backup purposes, then format the medium.	41
VIDEO MANAGEMENT FILE IS BROKEN. TO RECORD/ PLAYBACK VIDEO, RECOVERY IS REQUIRED. RECOVER?	● The video management file is broken. Recovery is required to record or play back video files. Press \wedge/\vee to select [YES], then press $\blacktriangleright\blacksquare$ to recover the video management file. If the desired video file is not displayed on the video index screen in spite of the file recovery, the file has been moved to the [EXTMOV] folder. Press the REC/SNAP button on the index screen to display [MPG], and then select the desired file.	31
NO VIDEO MANAGEMENT FILE VIDEO FILES HAVE BEEN MOVED TO MPEG FOLDER	● The data cannot be recorded properly, or the video management file has been deleted or cannot be found. Video files have been moved to MPEG (EXTMOV) folder.	31
CAN NOT READ EVENT INFORMATION	● Appears when the event information cannot be read.	-
PLAYLIST'S MANAGEMENT INFORMATION IS BROKEN. REMAKE PLAYLIST AGAIN.	● The management information of the playlist is broken. Create the playlist again.	44
NO REGISTERED SCENES IN PLAYLIST. SOME OF SCENES MAY NOT BE PLAYED BACK.	● The video files registered in the playlist do not exist. Some of the scenes may not be played back.	-
REGISTERED SCENES IN PLAYLIST IS EMPTY. THIS PLAYLIST WILL BE DELETED.	● There are no scenes registered in the playlist. The playlist will be deleted.	-
CAMERA TEMPERATURE IS GOING UP. TURN CAMERA OFF, PLEASE WAIT.	● The temperature of the camera is too high. Turn off the power, then wait for a while.	-
CAMERA TEMPERATURE IS TOO LOW. KEEP CAMERA POWER ON, PLEASE WAIT.	● The temperature of the camera is too low. Keep the power on and wait for a while.	-

Indication	Meaning	
RECORDING FAILURE	● Performance of recording medium is poor. Use the Cleanup function [CLEAN UP] in the menu.	42
	● The writing speed of recording medium is slow, or the recording medium is corrupted. Use an SD card that is guaranteed to operate.	3
	● The recording medium was subjected to vibrations or jolts. Be careful not to subject the recording medium to vibrations or jolts.	17
	● Appears when the built-in hard disk is full and recording is not possible. Delete unnecessary files.	–
	● Appears when the SD card is full and recording is not possible. Replace with new recording medium or delete unnecessary files.	38
RECORDING MAY NOT BE CORRECT ON THE MEMORY CARD	● The data may not be recorded on the recording medium correctly. Try recording again.	38
	● Otherwise, clean up the recording medium.	42
MEMORY CARD CANNOT BE PLAYED BACK CORRECTLY	● The recording medium cannot be played back correctly. Try playback again.	–
CANNOT USE IN VIDEO MODE	● The operation is not available in the video mode.	–
DROP DETECTION WORKED AND THE POWER IS TURNED OFF	● The drop detection function operated, and the power was turned off. The file that was being recorded may have been saved into the [EXTMOV] folder.	31 55

Cleaning the Camera

Before cleaning, turn off the camera and remove the battery pack and AC adapter.

To clean the exterior

Wipe gently with a soft cloth. If the camera is particularly dirty, dip the cloth into diluted mild soap and wring it out well before wiping. Then wipe again with a dry cloth.

To clean the LCD monitor

Wipe gently with a soft cloth. Be careful not to damage the monitor.

To clean the lens

Wipe gently with lens cleaning paper.

NOTES:

- Avoid using strong cleaning agents such as benzine or alcohol.
- Cleaning should be done only after the battery pack has been removed or other power units have been disconnected.
- Mold may form if the lens is left dirty.
- When using a cleaner or chemically treated cloth, refer to the cautions for each product.

AC Adapter

When using the AC adapter in areas other than the USA

The provided AC adapter features automatic voltage selection in the AC range from 110 V to 240 V.

USING HOUSEHOLD AC PLUG ADAPTER

In case of connecting the unit's power cord to an AC wall outlet other than American National Standard C73 series type use an AC plug adapter, called a "Siemens Plug", as shown.

For this AC plug adapter, consult your nearest JVC dealer.

Plug Adapter

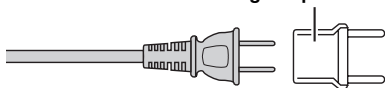

Battery Packs

The supplied battery pack is a lithium-ion battery. Before using the supplied battery pack or an optional battery pack, be sure to read the following cautions:

• To avoid hazards

...do not burn.

...do not short-circuit the terminals. When transporting, make sure the provided battery cap is attached to the battery. If the battery cap is misplaced, carry the battery in a plastic bag.

...do not modify or disassemble.

...do not expose the battery to temperatures exceeding 60°C (140°F), as this may cause the battery to overheat, explode or catch fire.

...use only specified chargers.

• To prevent damage and prolong service life

...do not subject to unnecessary shock.

...charge in an environment where temperatures are within the tolerances shown in "Temperature range specifications" (⇨ pg. 67). This is a chemical reaction type battery — cooler temperatures impede chemical reaction, while warmer temperatures can prevent complete charging.

...store in a cool, dry place. Extended exposure to high temperatures will increase natural discharge and shorten service life.

...fully charge and then fully discharge the battery every 6 months when storing the battery pack over a long period time.

...remove from charger or powered unit when not in use, as some machines use current even when switched off.

Terminals

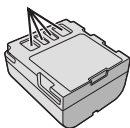

NOTES:

• It is recommended that only genuine JVC batteries are used in this camera. Using generic non-JVC batteries can cause damage to the internal charging circuitry.

• It is normal for the battery pack to be warm after charging, or after use.

Temperature range specifications

Charging: 10°C to 35°C (50°F to 95°F)

Operation: 0°C to 40°C (32°F to 104°F)

Storage: -20°C to 50°C (-4°F to 122°F)

• The lower the temperature, the longer the recharging takes.

DANGER! Do not attempt to take the batteries apart, or expose them to flame or excessive heat, as it may cause a fire or explosion.

WARNING! Do not allow the battery or its terminals to come in contact with metals, as this can result in a short circuit and possibly start a fire.

To resume the original function of the accurate battery power indication

If the battery power indication differs from the actual operating time, fully charge the battery, and then run it down. However this function may not work properly if the battery was used for a long period of time under extremely high/low temperature condition or charged too many times.

Recording Medium

• Be sure to follow the guidelines below to prevent corruption or damage to your recorded data.

- Do not bend or drop the recording medium, or subject it to strong pressure, jolts or vibrations.
- Do not splash the recording medium with water.
- Do not use, replace, or store the recording medium in locations that are exposed to strong static electricity or electrical noise.
- Do not turn off the camera power or remove the battery or AC adapter during shooting, playback, or when otherwise accessing the recording medium.
- Do not bring the recording medium near objects that have a strong magnetic field or that emit strong electromagnetic waves.
- Do not store the recording medium in locations with high temperature or high humidity.
- Do not touch the metal parts.
- Copy the recorded files to your PC. JVC shall not be responsible for any lost data. (It is recommended that you copy the data from your PC to DVD or other media for storage.)
- A malfunction may cause the recording medium to fail to operate properly. JVC shall not provide any compensation for any lost contents.

Recording Medium (Continued)

- Do not strike or shake the hard disk.
- When the camera is repaired or inspected, data may be erased, and the hard disk may be formatted. Back up all data before requesting repair or inspection.
- Play back your trial recording to make sure the video and audio have been recorded properly.
- When formatting or erasing data using the camera, only the file administration information is changed. The data is not completely erased from the hard disk. If you want to completely erase all of the data, we recommend either using commercially available software that is specially designed for that purpose, or by physically destroying the camera with a hammer etc.

LCD Monitor

- **To prevent damage to the LCD monitor, DO NOT**
 - ... push it strongly or apply any shocks.
 - ... place the camera with LCD monitor on the bottom.
- **To prolong service life**
 - ... avoid rubbing it with coarse cloth.
- **The following phenomena for LCD monitor use are not malfunctions.**
 - ... While using the camera, the surface around the LCD monitor may heat up.
 - ... If you leave power on for a long time, the surface around the LCD monitor becomes hot.

Main Unit

- **For safety, DO NOT**
 - ... open the camera's chassis.
 - ... disassemble or modify the unit.
 - ... short-circuit the terminals of the battery pack. Keep it away from metallic objects when not in use.
 - ... allow inflammables, water or metallic objects to enter the unit.
 - ... remove the battery pack or disconnect the power supply while the power is on.
 - ... leave the battery pack attached when the camera is not in use.
 - ... place naked flame sources, such as lighted candles, on the apparatus.
 - ... expose the apparatus to dripping or splashing.
- **Avoid using the unit**
 - ... in places subject to excessive humidity or dust.
 - ... in places subject to soot or steam such as near a cooking stove.
 - ... in places subject to excessive shock or vibration.
 - ... near a television set.
 - ... near appliances generating strong magnetic or electric fields (speakers, broadcasting antennas, etc.).
 - ... in places subject to extremely high (over 40°C or 104°F) or extremely low (under 0°C or 32°F) temperatures.
- **DO NOT leave the unit**
 - ... in places of over 50°C (122°F).
 - ... in places where humidity is extremely low (below 35%) or extremely high (above 80%).
 - ... in direct sunlight.
 - ... in a closed car in summer.
 - ... near a heater.
 - ... in high places such as on a TV. Leaving the unit in high places while a cable is connected may result in a malfunction if the cable is caught and the unit falls onto the floor.
- **To protect the unit, DO NOT**
 - ... allow it to become wet.
 - ... drop the unit or strike it against hard objects.
 - ... subject it to shock or excessive vibration during transportation.
 - ... keep the lens directed at extremely bright objects for long periods.
 - ... expose the lens to direct sunlight.
 - ... swing it excessively when using the hand strap.
 - ... swing the soft camera case excessively when the camera is inside it.

How to Handle a CD-ROM

- Take care not to soil or scratch the mirror surface (opposite to the printed surface). Do not write anything or put a sticker on either the front or back surface. If the CD-ROM gets dirty, gently wipe it with a soft cloth outward from the center hole.
- Do not use conventional disc cleaners or cleaning spray.
- Do not bend the CD-ROM or touch its mirror surface.
- Do not store your CD-ROM in a dusty, hot or humid environment. Keep it away from direct sunlight.

Serious malfunctioning

If malfunctioning occurs, stop using the unit immediately and consult your local JVC dealer.

When requesting repairs for malfunctioning by your dealer or JVC service center, be sure to bring your camera together with the recording medium. If one of them is not included, the cause cannot be diagnosed, and the repair cannot be made properly.

The camera is a microcomputer-controlled device. External noise and interference (from a TV, a radio, etc.) might prevent it from functioning properly. In such cases, first disconnect its power supply unit (battery pack, AC adapter, etc.) and wait a few minutes and then re-connect it and proceed as usual from the beginning.

Declaration of Conformity

Model Number : GZ-MG77U
 Trade Name : JVC
 Responsible party : JVC AMERICAS
 CORP.
 Address : 1700 Valley Road
 Wayne, N. J. 07470
 Telephone Number : 973-317-5000

This device complies with Part 15 of FCC Rules. Operation is subject to the following two conditions: (1) This device may not cause harmful interference, and (2) this device must accept any interference received, including interference that may cause undesired operation.

Changes or modifications not approved by JVC could void the user's authority to operate the equipment. This equipment has been tested and found to comply with the limits for a Class B digital device, pursuant to Part 15 of the FCC Rules. These limits are designed to provide reasonable protection against harmful interference in a residential installation. This equipment generates, uses, and can radiate radio frequency energy and, if not installed and used in accordance with the instructions, may cause harmful interference to radio communications. However, there is no guarantee that interference will not occur in a particular installation. If this equipment does cause harmful interference to radio or television reception, which can be determined by turning the equipment off and on, the user is encouraged to try to correct the interference by one or more of the following measures:

Reorient or relocate the receiving antenna.
 Increase the separation between the equipment and receiver.

Connect the equipment into an outlet on a circuit different from that to which the receiver is connected.

Consult the dealer or an experienced radio/TV technician for help.

This Class B digital apparatus complies with Canadian ICES-003.

Cet appareil numérique de la classe B est conforme à la norme NMB-003 du Canada.

Camera

For general

Power supply

DC 11 V (Using AC adapter)

DC 7.2 V (Using battery pack)

Power consumption

Approx. 4.6 W

Approx. 6.5 W (Maximum; when charging a battery)

Dimensions (W x H x D)

68 mm x 69 mm x 109 mm

(2-11/16" x 2-3/4" x 4-5/16")

Weight

Approx. 370 g (0.75 lbs)

(without battery, lens cap and strap)

Approx. 430 g (0.89 lbs)

(incl. battery, lens cap and strap)

Operating temperature

0°C to 40°C (32°F to 104°F)

Operating humidity

35% to 80%

Storage temperature

-20°C to 50°C (-4°F to 122°F)

Pickup

1/3.9" (2,180,000 pixels) CCD

Lens

F 1.2 to 2.0, f = 3.8 mm to 38 mm, 10:1 power zoom lens

Filter diameter

ø30.5 mm

LCD monitor

2.7" diagonally measured, LCD panel/TFT active matrix system

Speaker

Monaural

Flash

Within 2 m (6.6 ft)

(recommended shooting distance)

For video/audio

Format

SD-VIDEO

Recording/Playback format

Video: MPEG-2

Audio: Dolby Digital (2 ch)

Signal format

NTSC standard

Recording mode (video)

ULTRA FINE: 720 x 480 pixels, 8.5 Mbps (VBR)

FINE: 720 x 480 pixels, 5.5 Mbps (VBR)

NORMAL: 720 x 480 pixels, 4.2 Mbps (VBR)

ECONOMY: 352 x 240 pixels, 1.5 Mbps (VBR)

Recording mode (audio)

ULTRA FINE: 48 kHz, 384 kbps

FINE: 48 kHz, 384 kbps

NORMAL: 48 kHz, 256 kbps

ECONOMY: 48 kHz, 128 kbps

For still image

Format

JPEG

Image size

4 modes (1632 x 1224 / 1280 x 960 / 1024 x 768 / 640 x 480)

Picture quality

2 modes (FINE/STANDARD)

For connectors

AV

S-Video output:

Y: 1.0 V (p-p), 75 Ω, analog

C: 0.29 V (p-p), 75 Ω, analog

Video output: 1.0 V (p-p), 75 Ω, analog

Audio output: 300 mV (rms), 1 kΩ, analog, stereo

USB

Mini USB type A and type B, USB 2.0 compliant

AC Adapter

Power requirement

AC 110 V to 240 V~, 50 Hz/60 Hz

Output

DC 11 V , 1 A

Remote Control

Power supply

DC 3 V

Battery life

Approx. 1 year (depending on the frequency of use)

Operating distance

Within 5 m (16.4 ft)

Operating temperature

0°C to 40°C (32°F to 104°F)

Dimensions (W x H x D)

45 mm x 13 mm x 105 mm

(1-13/16" x 1-1/2" x 4-3/16")

Weight

Approx. 40 g (0.09 lbs)

(incl. battery)

Design and specifications subject to change without notice.

Recording Time and Number of Images

The tables below show the approximate recording time and number of storable images. The number increases or decreases depending on the conditions such as image size and/or picture quality.

Approximate recording time (minutes) (for video)

Quality [] = Factory-preset	HDD	SD Card				
		128 MB	256 MB	512 MB	1 GB	2 GB
[ULTRA FINE]	430	1	3	7	14	29
FINE	640	2	5	10	21	43
NORMAL	850	3	6	14	27	57
ECONOMY	2250	8	18	37	73	152

Approximate number of storable images (for still image)

Quality [] = Factory-preset	HDD	SD Card				
		128 MB	256 MB	512 MB	1 GB	2 GB
1632 x 1224 / [FINE]	9999	140	280	560	1130	2210
1632 x 1224 / STANDARD		235	470	935	1890	3645
1280 x 960 / [FINE]	9999	220	440	880	1780	3440
1280 x 960 / STANDARD		350	705	1405	2835	5635
1024 x 768 / [FINE]	9999	325	645	1285	2600	5165
1024 x 768 / STANDARD		555	1110	2205	4455	8855
640 x 480 / [FINE]	9999	780	1555	3090	6240	9999
640 x 480 / STANDARD		1115	2225	4415	8915	9999

NOTE:

For details on compatible SD cards, see "Check the compatibility of recording media" (▶ pg. 3).

A	
AC Adapter	14, 67
B	
Backlight Compensation	27
Battery Pack	14
Brightness Control	56
C	
Changing Event Registration	58
Changing the Menu Settings	54
Cleaning Up a Recording Medium	42, 56
Clock Adjust	57
Connecting to a TV, VCR or DVD Recorder	34
Continuous Shooting	23, 59
Copying/Moving Still Image Files	53, 56
D	
Data Battery	16
Date Display Order	57
Date Index Screen	30
Date/Time Setting	15
Deleting Files	38
Demonstration Mode	55
Digital Image Stabilizer (DIS)	57
Direct Printing	48, 59
Drop Detection	55
Dubbing	49
DVD Creation Function	49
E	
Effect	36, 58, 59
Event Registration	19, 57
Event Screen	31
EXTMOV Folder	19, 31
F	
File Information	39
Flash	23
Focus	25
Formatting a Recording Medium	41, 56
G	
Gain Up/Gain	57, 59
H	
Hard Disk	2
I	
Image Rotation	33
Image Size	59
L	
Language Setting	15, 56
LCD Monitor	10, 68
Lens Cap	9
M	
Manual Exposure	25
Manual Focus	25
Manual Recording	24
MSET Menu	24
N	
Nightalive	27
Number of Storable Images	71
O	
On-Screen Display	12, 57
Operation Sound	55
P	
PictBridge	48
Picture Quality	57, 59, 71
Playlist	44, 58
Power Switch	14
Power-Linked Operation	10
Program AE	26
Protecting Files	40, 58, 59
R	
Rec Media Setting	56
Recording Medium	67
Recording Time	71
Remote Control	35, 55
Resetting the File Number	42, 56
S	
Scene Counter	56
Screen Size (16:9/4:3)	20
SD Card	17
Self-Timer	59
Shutter Speed	26
Slide Show	33
Slow Motion Playback	29
Speaker Volume	28
Spot Exposure Control	27
Still Image	22, 32
T	
Tele Macro	57, 59
Tripod Mounting	16
V	
Video	18, 28
W	
White Balance	25
Wind Cut	57
Wipe or Fader Effects	36
Z	
Zooming	20, 23, 29, 33, 57

JVC